

  
**PURSUIT**®



OWNER'S MANUAL

**DC 246**  
DUAL CONSOLE

---

# CALIFORNIA PROPOSITION 65 WARNING

## **WARNING**

**WARNING: OPERATING, SERVICING AND MAINTAINING A RECREATIONAL MARINE VESSEL CAN EXPOSE YOU TO CHEMICALS INCLUDING ENGINE EXHAUST, CARBON MONOXIDE, PHTHALATES, AND LEAD, WHICH ARE KNOWN TO THE STATE OF CALIFORNIA TO CAUSE CANCER AND BIRTH DEFECTS OR OTHER REPRODUCTIVE HARM. TO MINIMIZE EXPOSURE, AVOID BREATHING EXHAUST, SERVICE YOUR VESSEL IN A WELL-VENTILATED AREA AND WEAR GLOVES OR WASH YOUR HANDS FREQUENTLY WHEN SERVICING THIS VESSEL. FOR MORE INFORMATION GO TO [WWW.P65WARNINGS.CA.GOV/MARINE](http://WWW.P65WARNINGS.CA.GOV/MARINE).**

**U.S. Patents**

**8,113,137**

**Other patents pending**

# Safety Information

Your Owner's Manual was written to include safety instructions to ensure safe operation and maintenance of your boat. Safety alerts symbols are used to alert potential personal injury hazards.

## DANGER

Indicates a hazardous situation which, if not avoided, will result in death or serious injury.

## WARNING

Indicates a hazardous situation which, if not avoided, could result in death or serious injury.

## CAUTION

Indicates a hazardous situation which, if not avoided, could result in minor or moderate injury.

## NOTICE

Indicates a potentially hazardous situation which, if not avoided, may result in property damage.

All instructions are viewed from the stern looking toward the bow, with starboard (to your right) and port (to your left). A glossary of boating terms is included.

Your boat produces carbon monoxide (CO) and uses flammable fuel. CO will cause BRAIN DAMAGE or DEATH. Carbon monoxide gas (CO) is colorless, odorless and extremely dangerous.

Every precaution has been taken by Pursuit Fishing Boats to reduce the risks associated with death, possible injury and damage from fire or explosion. Your own precaution and good maintenance proce-

dures are necessary in order to enjoy safe operation of your boat.

## DANGER

Exposure to carbon monoxide will cause death or serious injury. Avoid direct and prolonged exposure to CO.

Gasoline and other fuels are extremely flammable and highly explosive under certain conditions.

- DO NOT smoke or allow open flame or sparks nearby when fueling.
- DO NOT block fuel vents.
- DO NOT store fuel in any containers or compartments which are not designated for storing fuel.

## WARNING

The State of California has identified chemicals that could potentially be linked to cancer or reproductive complications. Operating, servicing and maintaining a recreational marine vessel can expose you to chemicals including engine exhaust, carbon monoxide, phthalates, and lead, which are known to the State of California to cause cancer and birth defects or other reproductive harm. To minimize exposure, avoid breathing exhaust, service your vessel in a well-ventilated area and wear gloves or wash your hands frequently when servicing this vessel. For more information go to:  
<http://www.P65warnings.ca.gov/marine>.



# Table of Contents

---

## Safety Information

Safety Information ..... ii

## Safety Label Locations

Label List ..... 2

Label Table ..... 3

## General Information

Engine and General Specifications ..... 7

Boat Information ..... 8

Warranty & Warranty Registration Cards ... 9

Federal Boating Safety Act ..... 9

Product Changes ..... 9

Transferring the Warranty ..... 9

Owner/Operator Responsibilities ..... 9

Towing ..... 9

Registration and Documentation ..... 10

Insurance ..... 10

Reporting Boating Accidents ..... 10

Education ..... 10

Required Equipment ..... 11

EPA Compliant Fuel System ..... 11

## Propulsion Systems

1.1 General ..... 1-1

1.2 Saltwater Application ..... 1-1

1.3 Engine Lubrication ..... 1-2

1.4 Engine Cooling System ..... 1-2

1.5 Propellers ..... 1-2

1.6 Engine Instrumentation ..... 1-2

## Helm Systems

2.1 General ..... 2-1

2.2 Engine Throttle and Shift Controls . 2-1

2.3 Neutral Safety Switch ..... 2-1

2.4 Engine Power Tilt and Trim ..... 2-2

2.5 Engine Stop Switch ..... 2-2

2.6 Steering System ..... 2-3

2.7 Optional Electronics ..... 2-4

2.8 Compass ..... 2-4

2.9 Control Systems Maintenance ..... 2-4

## Fuel Systems

3.1 General ..... 3-1

3.2 Fuel System ..... 3-2

3.3 Fueling Instructions ..... 3-3

## Electrical Systems

4.1 General ..... 4-1

4.2 DC System ..... 4-1

4.3 Main Breakers/Helm Electronics ... 4-2

4.4 12-Volt DC Panel ..... 4-3

4.5 Electrical System Maintenance ..... 4-5

## Plumbing Systems

5.1 Fresh Water System ..... 5-1

5.2 Raw Water Washdown ..... 5-1

5.3 Livewell ..... 5-2

5.4 Drainage ..... 5-2

5.5 Plumbing System Maintenance ..... 5-4

## Ventilation Systems

6.1 Carbon Monoxide  
and Proper Ventilation ..... 6-1

## Exterior Equipment

7.1 Deck ..... 7-1

7.2 Cockpit ..... 7-2

## Interior Equipment

8.1 Port Console ..... 8-1

8.2 Audio and Video Systems ..... 8-2

# Table of Contents

---

## Safety Equipment

9.1	General .....	9-1
9.2	Engine Alarms .....	9-1
9.3	Neutral Safety Switch .....	9-1
9.4	Engine Stop Switch .....	9-1
9.5	Carbon Monoxide Hazards .....	9-2
9.6	First Aid .....	9-4
9.7	Required Safety Equipment .....	9-5
9.8	Additional Safety Equipment .....	9-8

## Operation

10.1	General .....	10-1
10.2	Homeland Security Restrictions ...	10-1
10.3	Rules of the Road .....	10-2
10.4	Pre-Cruise Check .....	10-3
10.5	Operating your Boat .....	10-4
10.6	Fishing .....	10-6
10.7	Docking, Anchoring and Mooring ...	10-6
10.8	Controls, Steering or Propulsion System Failure .....	10-8
10.9	Collision .....	10-8
10.10	Grounding, Towing and Rendering Assistance .....	10-8
10.11	Flooding or Capsizing .....	10-9
10.12	Transporting your Boat .....	10-9
10.13	Trailer your Boat .....	10-9
10.14	Water Skiing .....	10-10
10.15	Man Overboard .....	10-11
10.16	Trash Disposal .....	10-11

## Routine Maintenance

11.1	General .....	11-1
11.2	Exterior Hull and Deck .....	11-1
11.3	Seats, Upholstery, Canvas and Enclosures .....	11-5
11.4	Cabin Interior .....	11-6
11.5	Bilge .....	11-6

## Seasonal Maintenance

12.1	Storage and Lay-up .....	12-1
12.2	Winterizing .....	12-2
12.3	Recommissioning .....	12-4

## Appendices

Glossary of Terms .....	A-1
Maintenance Schedule .....	B-1
Maintenance Log .....	B-2
Boating Accident Report .....	C-1
Float Plan .....	D-1
Troubleshooting Guide .....	E-1
Schematics .....	F-1
Fresh Water System .....	G-1
Aquatic Invasive Species .....	H-1

# Occupant Seating Positions

---

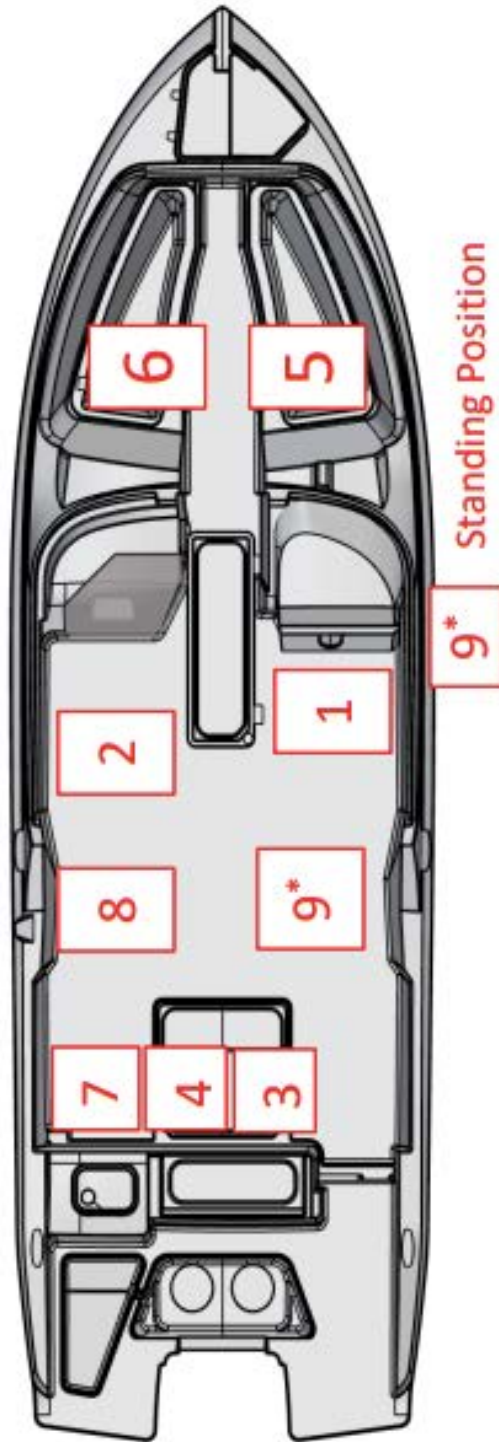

**\*\*NOTE\*\*** Position 7 is for Optional Port Transom Seat

**DC 246 Occupant Seating Positions**







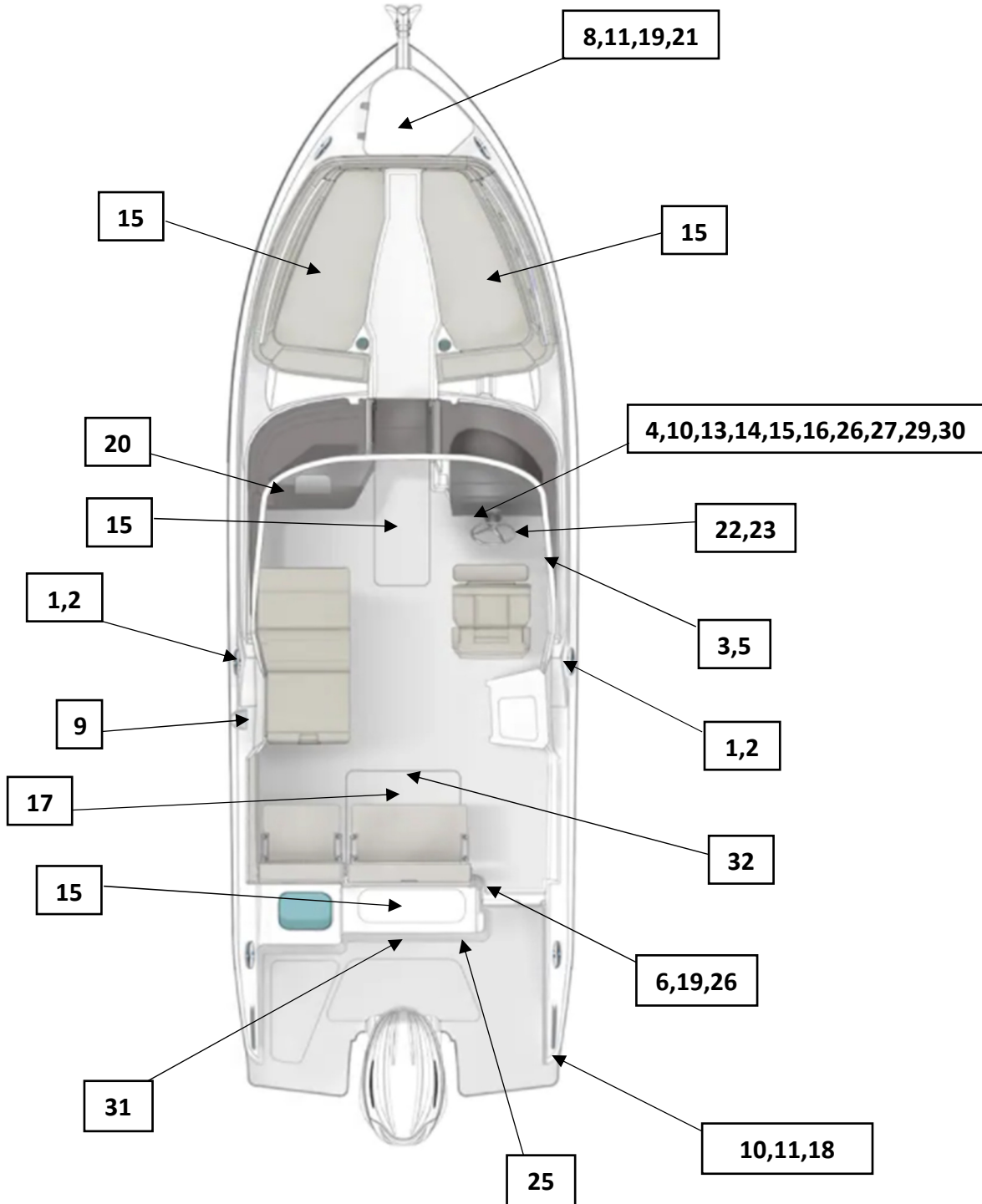



# Label Locations



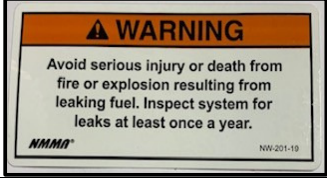
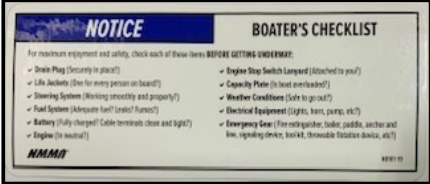



# Label Locations

## Labels Reference

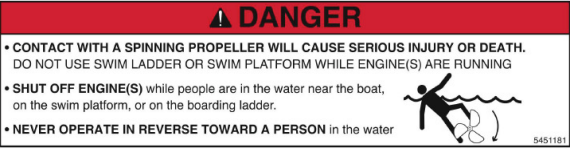
<p><b>1</b></p>	<p>LABEL,DESIGNATOR "DC 246" MY21 D4  PART #: 5450064</p>	
<p><b>2</b></p>	<p>LOGO,"P" PLATINUM INJECTION MOLDED  PART #: 5436800</p>	
<p><b>3</b></p>	<p>PLATE,CAPACITY DC 246 (US) MY21 D4  PART #: 5450063</p>	
<p><b>4</b></p>	<p>LABEL,FUEL SYSTEM WARNING MYLAR / NO.200  PART #: 5450060</p>	
<p><b>5</b></p>	<p>LABEL,BOATMAN'S CHECK LIST  PART #: 5450120</p>	
<p><b>6</b></p>	<p>LABEL,"RAW WATER"  PART #: 5450270</p>	
<p><b>7</b></p>	<p>LABEL,STORAGE AREA NOTICE MYLAR 3"X1-1/8  PART #: 5450710</p>	
<p><b>8</b></p>	<p>LABEL,GELCOAT DAMAGE NOTICE MYLAR 3"LONG  PART #: 5450720</p>	

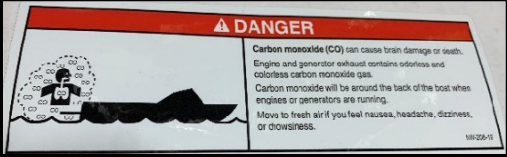
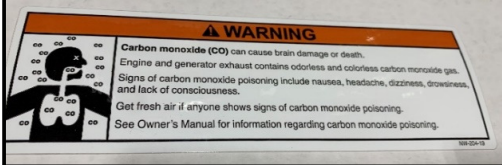
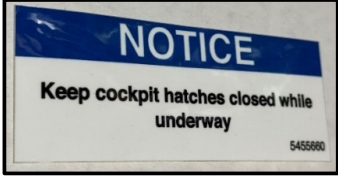

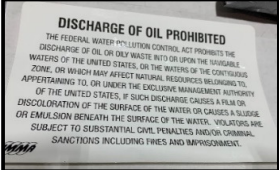





# Label Locations

<p>9</p>	<p>LABEL, NO SMOKING PART #: 5451130</p>	
<p>10</p>	<p>LABEL,DANGER PROPELLER, SWIM PLATFORM PART #: 5451181</p>	
<p>11</p>	<p>LABEL,SWIM LADDER DANGER PART #: 5451751</p>	
<p>12</p>	<p>LABEL,TRANSOM CO CALIFORNIA #NW-206-05 PART #: 5453650</p>	
<p>13</p>	<p>LABEL,WARNING CO HELM #NW-204-05 PART #: 5453690</p>	
<p>14</p>	<p>LABEL,NOTICE KEEP HATCHES CLOSED PART #: 5455660</p>	
<p>15</p>	<p>LABEL,WARNING NO FLAMMABLE LIQUIDS PART #: 5455950</p>	
<p>16</p>	<p>LABEL,"DISCHARGE OF OIL PROHIBITED",USCG PART #: 5454490</p>	

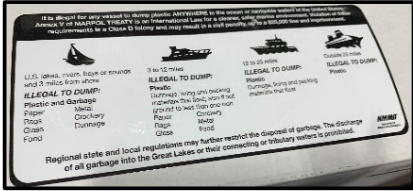
# Label Locations

<p><b>17</b></p>	<p>LABEL,"FORWARD" MECHANICAL HATCH PART #: 5450730</p>	
<p><b>18</b></p>	<p>LABEL,"NMMA" CERT SLVR/BLK 2IN CIRCLE PART #: 5455250</p>	
<p><b>19</b></p>	<p>LABEL,"FRESH WATER" PART #: 5450260</p>	
<p><b>20</b></p>	<p>LABEL,"FIRE EXTINGUISHER INSIDE" PART #: 5452010</p>	
<p><b>21</b></p>	<p>LABEL,NOTICE ANCH RODE LEWMAR #65001230 PART #: 5455970</p>	
<p><b>22</b></p>	<p>TAG,WARNING CA CODE PROP 65 #NW502-17 PART #: 5453551</p>	
<p><b>23</b></p>	<p>TAG,WARNING ETHANOL FUEL PART #: 5450041</p>	
<p><b>24</b></p>	<p>LABEL,MANUAL DOOR OVERRIDE "UP" PART #: 5451781</p>	

# Label Locations

<p>25</p>	<p>LABEL, "AMERICAN MADE" 2.4" X 12" PART #: 5455601</p>	
<p>26</p>	<p>LABEL,WARNING BOARDING DOOR PART #: 5450551</p>	
<p>27</p>	<p>LABEL,"TRASH OVERBOARD DISCHARGE" PART #: 5454500</p>	
<p>28</p>	<p>LABEL,WARNING WINDLASS LEWMAR #65001720 PART #: 5455960</p>	
<p>29</p>	<p>LABEL,HARDTOP DO NOT OCCUPY UNDERWAY PART #: 5453601</p>	
<p>30</p>	<p>LABEL,WARNING HARDTOP PART #: 5453160</p>	
<p>31</p>	<p>LABEL,DANGER "DO NOT EXCEED 1000LB CAP" PART #: 5455840</p>	
<p>32</p>	<p>LABEL, WARNING "DO NOT DRILL" PART #: 5455830</p>	

# General Information

---

## 1.1 Engine and General Specifications

Maximum Horsepower.....	350 HP (261 kW)
L.O.A .....	25' 8" (7,82 meters)
Beam .....	8' 6" (2,59 meters)
Draft (fully loaded, motors up).....	1' 9" (0,53 meters)
Draft (fully loaded, motors down) .....	2' 11" (0,89 meters)
Clearance with Hardtop (from waterline).....	7' 2" (1,88 meters)
Approximate Dry Weight.....	6,138 lbs. (2.785 kg)
Fuel Capacity.....	118 U.S. gallons (446,68 liters)
Water Capacity .....	18 U.S. gallons (68,14 liters)
Livewell Capacity .....	20 U.S. gallons (75,71 liters)
Transom Fishbox Capacity .....	31 U.S. gallons (117 liters)
Portable Toilet Capacity.....	5 U.S. gallons (18,93 liters)
Optional Electric Head Holding Tank Capacity .....	6 U.S. gallons (22,71 liters)
Deadrise at Transom .....	21 Degrees
Persons Capacity.....	9

**\*\*Net tank capacity. The usable fuel capacity will be affected by several factors, including EPA-required fuel system components, temperature and loading of the boat. These factors will reduce the usable fuel capacity by approximately 10%.**

# General Information

## Boat Information

Fill out the following information and leave it in your PURSUIT Owner's Manual. This information will be important for you and PURSUIT service personnel to know, if and when you may need to call PURSUIT for technical assistance or service.

Boat	
Model:	Hull Serial #:
Purchase Date:	Delivery Date:
Ignition Keys #:	Registration #:
Draft:	Weight:
Engine(s)	
Make:	Model:
Port Serial #:	Starboard Serial #:
Transmission(s) (Inboard)	
Make:	Model:
Port Serial #:	Starboard Serial #:
Ratio:	
Outdrive(s) (Inboard/Outboard)	
Make:	Model:
Port Serial #:	Starboard Serial #:
Propeller(s)	
Make:	Blades:
Diameter/Pitch:	Other:
Generator	
Make:	Model:
Serial #:	kW:
Dealer	Pursuit
Name:	Phone:
Dealer/Phone:	Representative:
Salesman:	Address:
Service Manager:	
Address:	

PURSUIT Fishing Boats reserves the right to make changes and improvements in equipment, design and vendor supplied equipment at any time without notification.

# General Information

---

## Warranty and Warranty Registration Cards

The PURSUIT Limited Warranty Statement is included with your boat. It has been written to be clearly stated and easily understood. If you have any questions after reading the warranty, please contact PURSUIT Customer Relations.

PURSUIT, engine manufacturers, and the suppliers of major components maintain their own manufacturer's warranty and service facilities. It is important that you properly complete the warranty registration cards included with your boat and engine(s) and mail them back to the manufacturers to register your ownership. This should be done within 15 days of the date of purchase and before the boat is put into service. A form for recording this information is provided at the beginning of this manual. This information will be important for you and service personnel to know, if and when you may need service or technical information.

The boat warranty registration requires the **Hull Identification Number "HIN"** which is located on the starboard side of the transom, just below the rub rail. The engine warranty registration requires the engine serial number(s). Please refer to the engine owner's manual for the location of the serial number(s).

## Federal Boat Safety Act

All boat manufacturers are required by the Federal Boat Safety Act of 1971 to notify first time owners in the event any defect is discovered "which creates a substantial risk of personal injury to the public." It is essential that we have your warranty registration card complete with your name and mailing address in our files so that we can comply with the law if it should become necessary.

## Product Changes

PURSUIT is committed to the continuous improvement of our boats. As a result, some of the equipment described in this manual or pictured in the catalog may change or no longer be available.

**PURSUIT reserves the right to change standard equipment, optional equipment and specifications without notice or obligation.** If you have questions about the equipment on your PURSUIT, please contact PURSUIT Customer Relations.

## Transferring the Warranty

Pursuit Boats will extend warranty coverage to subsequent owners of Pursuit models for the duration of the original warranty period. Please refer to the Pursuit Limited Warranty Statement for the procedure to transfer the warranty. To take advantage of this program, notification of the change of ownership, including the new owner's name, address and telephone number must be sent to Pursuit Boats, Customer Relations Department, 3901 St. Lucie Boulevard, Ft. Pierce, Florida 34946, within 30 days of resale.

Pursuit Boats will confirm, in writing, that the transfer of warranty has taken place. After which, the transferee will be treated as the original purchaser as outlined in the Pursuit Limited Warranty Statement.

## Owner/Operator Responsibilities

### Towing

Pursuit Boats offers a custom bow tow eye on certain models as an optional feature. If your boat is equipped with this optional feature the following operational guidelines must be followed to prevent damages or injury from occurring during towing operations:

Ensure that towing tackle is properly rated/sized for the weight of your vessel.

Inspect the towing tackle prior to and at the end of every towing operation.

Prior to towing, close all seacocks which are designed to pick up raw water for air conditioning, generator, washdown pumps and live wells. Close all seacocks which are designed to discharge water through the hull bottom or hull sides for macerators, fish box pumps and deck drains. This will prevent flooding of mechanical spaces if a break in a



# General Information

line were to occur. Since it is assumed the vessel will be unoccupied during towing operations this is a critical step prior to beginning the towing operation.

On boats equipped with a generator, the generator exhaust outlet must be sealed to prevent water filling exhaust and flooding generator engine block/cylinders. This can be accomplished by installing an expandable plug in the exhaust outlet. Note, after a towing operation is completed and prior to starting the generator, the exhaust outlet plug must be removed. Failure to remove the exhaust outlet plug can lead to damage to the generator, it's exhaust system and/or associated components.

Sea conditions will dictate the speed at which your boat can be safely towed. Be mindful of changing conditions and adjust towing speeds accordingly.

It is the owner's responsibility to ensure these guidelines are followed during all towing operations. Failure to follow the guidelines can possibly lead to damages or injury. Damages to equipment and/or the vessel which are deemed to be caused by failure to follow the guidelines can void any warranty coverage.

On models which do not offer an optional factory installed custom bow tow eye, owner will assume all responsibility for damages to the vessel and equipment which are deemed the result of installation and or use of the non-factory tow eye.

## Registration and Documentation

Federal law requires all undocumented vessels equipped with propulsion machinery be registered in the state of principal use. A certificate of documentation will be issued upon registration. These registration numbers must be displayed on your boat. The owner/operator of a boat must carry a valid certificate of registration whenever the boat is in use. When moved to a new state of principal use, the certificate is valid for 60 days.

In order to be valid, the numbers must be installed to the proper specifications. Check with your dealer or state boating authority for numbering requirements. The Coast Guard

issues the certificate of number in Alaska; all others are issued by the state.

## Insurance

In most states the boat owner is legally responsible for damages or injuries the boat causes. Responsible boaters carry adequate liability and property damage insurance for their boat. You should also protect the boat against physical damage and theft. Some states have laws requiring minimum insurance coverage. Contact your dealer or state boating authority for information on the insurance requirements in your boating area.

## Reporting Boating Accidents

All boating accidents must be reported by the owner or operator of the boat to the proper marine law enforcement authority for the state in which the accident occurred. Immediate notification is required if a person dies or disappears as a result of a recreational boating accident.

If a person dies or there are injuries requiring more than first aid, a formal report must be filed within 48 hours.

A formal report must be made within 10 days for accidents involving more than \$500.00 damage or the complete loss of a boat.

A "Boating Accident Report" form is located near the back of this manual to assist you in reporting an accident. If you need additional information regarding accident reporting, please call the Boating Safety Hotline, 800-368-5647 or [uscgboating.org](http://uscgboating.org).

## Education

If you are not an experienced boater, we recommend the boat operator and other people that normally accompany the operator, enroll in a boating safety course. Organizations such as the U.S. Power Squadrons, United States Coast Guard Auxiliary, State Boating Authorities and the American Red Cross offer excellent boating educational programs. These courses are worthwhile even for experienced boaters to sharpen your skills or bring you up to date on current rules and regulations. They can also help in pro-

# General Information

---

viding local navigational information when moving to a new boating area. Contact your dealer, State Boating Authority or the Boating Safety Hotline, 800-368-5647 or [uscg-boating.org](http://uscg-boating.org) for further information on boating safety courses.

## Required Equipment

U.S. Coast Guard regulations require certain equipment on each boat. The Coast Guard also sets minimum safety standards for vessels and associated equipment. To meet these standards some of the equipment must be Coast Guard approved. "Coast Guard Approved Equipment" has been determined to be in compliance with USCG specifications and regulations relating to performance, construction or materials. The equipment requirements vary according to the length, type of boat, and the propulsion system. Some of the Coast Guard equipment is described in the Safety Equipment Section of this manual. For a more detailed description, obtain "Federal Requirements and Safety Tips for Recreational Boats" by contacting the Boating Safety Hotline 800-368-5647, [uscgboating.org](http://uscgboating.org) or your local marine dealer or retailer.

Some state and local agencies go beyond USCG regulations or impose similar equipment requirements on waters that do not fall under Coast Guard jurisdiction. Contact your dealer or local boating authority, they can provide you with additional information for the equipment requirements for that boating area.

## EPA Compliant Fuel System

EPA (Environmental Protection Agency) regulations have required additional emissions related components for the fuel tank, fuel fill and fuel vent systems. It is unlawful to remove or intentionally defeat these emission related components.



## Propulsion Systems

### 1.1 General

Your Pursuit boat is designed to be powered with a 4-cycle outboard engine.

Each manufacturer of the various outboard engines provides an owner's information manual which includes its limited warranty statement with its product. It is important you read and understand the information and become familiar with the warranty, operation and maintenance of the engines and drive systems.

#### NOTICE

**DO NOT attempt to service any part of the outboard or boat systems unless you are familiar and qualified to do so. Do not use parts which are not designed for a marine application.**

#### WARNING

**MOVING PARTS HAZARD**  
Contact with moving parts can entangle, cut and cause death or serious injury. **DO NOT** get close enough to make contact with any running machinery moving parts, i.e., engine or propeller. Contact can result in loss of body parts, strangulation, burns and/or severe loss of blood resulting in death or serious injury.

#### NOTICE

**Use only the fuel recommended by the engine manufacturer. Use of old, contaminated fuel can cause the engine to malfunction or severe damage.**

### 1.2 Saltwater Application

Each outboard engine is a complete drive system with the gear case (transmission) forward of the propeller and connected to the power head with a vertical drive shaft. Other than the routine maintenance outlined in the engine owner's manual, there is little to be concerned with unless the boat is to be kept in saltwater for extended periods. Marine growth will occur when components are left in the water for extended periods and can cause poor performance or permanent damage to the exposed components. The type of growth and how quickly it occurs is relative to the water conditions in your boating area. Water temperature, pollution, current, etc. can have an effect on marine growth.

#### NOTICE

**DO NOT use copper-based coatings or any coatings not approved for use with aluminum. Some paint manufacturers claim their paints are safe for aluminum. Copper components and copper-based paints can cause severe corrosion to aluminum. DO NOT use copper-based paints. Mercury or mercury-based compounds that come into contact with aluminum will result in severe corrosion.**

Galvanic corrosion is the corrosion process occurring when different metals are submerged in an electrolyte. Sea water is an electrolyte and submerged engine components must be properly protected. Outboard engines are equipped with sacrificial anodes to help prevent galvanic corrosion problems. The anodes must be monitored and replaced as necessary. For locations and maintenance, refer to the engine owner's manual.

When leaving the boat in the water, tilt the motors as high as possible to decrease the risk of marine growth around the cooling inlets, propeller and exhaust ports and damage from galvanic corrosion.

## 1.3 Engine Lubrication

4-cycle engines have an oil sump in the crankcase. The oil type, grade and level must be followed in accordance with the engine manufacturer's recommendation. It is normal for 4-cycle engines to consume a small amount of oil. Check the oil level before each use and change it following the engine manufacturer's recommendation.

### NOTICE

**Use only the oil recommended by the engine manufacturer, and monitor the oil level. Use of any other type of oil can cause the engine to malfunction or severe damage.**

## 1.4 Engine Cooling System

Outboard engines are raw water (sea water) cooled. Water is pumped through the water inlets, circulated through the engine block, and expelled with the exhaust through exhaust port, water port and the propeller hub. The water pump uses a small impeller made of synthetic rubber. The impeller and water pump cannot run dry for more than a few seconds. In most outboard engines, some cooling water is diverted through ports below the engine cowling. This allows the

operator to visually check the operation of the cooling system. When the engine is started, make sure a steady stream of water is present.

### NOTICE

**DO NOT operate an engine out of the water, even momentarily. Water must be supplied to the cooling system of the power head and water pump, or serious damage will result. If it is necessary to run the engine out of the water, connect it to an engine flush attachment design for your specific engine.**

If the boat is used in salt or badly polluted water, flush the engines after each use to reduce corrosion. Refer to the engine owner's manual for the proper engine flushing procedure.

## 1.5 Propellers

The propellers convert the power of the engines into thrust. Propellers vary in style, diameters and pitch. The best set for your needs will depend on your application and expected average load. Propeller sizes are identified by two numbers stamped on the prop in sequence; the first is the diameter and the second is the pitch (example 14 x 21). Pitch is the theoretical distance the propeller will travel in one rotation. Repair or replace a propeller immediately if it has been damaged. A damaged propeller can cause vibration that can be felt in the boat and can damage the engine gear case. Refer to the engine owner's manual for information on propeller removal and installation.

## 1.6 Engine Instrumentation

The helm station is equipped with a Yamaha Command Link Plus Multi-guage. This display allows the operator to view important engine and vessel conditions on one screen. Some of the functions available are discussed in the following headings. For more detailed information on the Command Link

# Propulsion Systems

Plus display see the enclosed manual. Monitoring the instrumentation allows the operator to operate the engines most efficiently and prevent serious costly damage.

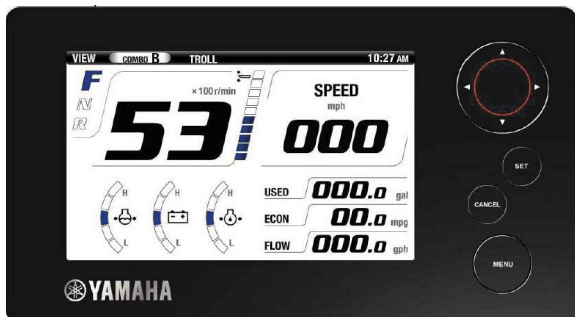

## Tachometer

The tachometer displays the speed of the engine in revolutions per minute (RPM). This speed is not the boat speed or the speed of the propeller. The tachometer may not register zero with the key in the “OFF” position.

### NOTICE

**DO NOT exceed maximum recommended engine RPM. Exceeding, maintaining or close to maintaining maximum RPM can reduce engine life.**

## Speedometer

The speedometer indicates the speed of the boat in miles per hour (MPH). Most speedometers measure the water pressure against a small hole in a pick-up tube located in the engine lower unit or from GPS in a Yamaha® installation.

## Temperature Warning

The temperature warning indicates the temperature of the engine. A sudden increase in the temperature could indicate an obstructed water inlet or an impeller failure.

### NOTICE

**Continued operation of an overheated engine will cause severe engine damage. If the engine overheats, shut off the engine, investigate the problem and correct it.**

## Fuel Gauge

The fuel gauge indicates the approximate fuel level in the fuel tanks. This gauge is a relative indication of the fuel supply available; it is not a calibrated instrument.

## Voltmeter

The voltmeter displays the voltage for the battery and the charging system. The normal voltage for a full charged battery is 12.6 volts with the engine(s) off and 13 to 14.5 volts with the engine(s) running.

## Hourmeter

The hourmeter keeps a running total of engine hours while operating.

## Tilt/Trim Gauge

The tilt/trim gauge monitors the position of the outboard engine. The upper range of the gauge indicates the tilt, which is used for shallow water operation, trailering and to keep the gear case out of the water. The lower range indicates the trim position. Trim is used to adjust the hull angle while operating your boat on plane. Refer to the engine owner’s manual for more information on the operation of the outboard power tilt and trim.

## Engine Alarms

Most outboards are equipped with an audible alarm system mounted in the helm area to monitor selected critical engine systems and functions. The alarm will sound if one of these systems begins to fail. Refer to the engine owner's manual for information on the alarms installed with your engines.

### **NOTICE**

**If an engine alarm sounds, shut off the engine, investigate the problem and correct it.**

## Helm Systems

### 2.1 General

The helm controls consist of engine throttle and shift controls, steering system, trim tab control switches and the optional spotlight control.

Each manufacturer of the control components provides an owner's manual with its product. It is important that you read, understand and become familiar with the proper care and operation of all control systems.

### WARNING

#### **LOSS OF CONTROL AND UNSAFE BOAT HAZARD**

**Hazard from improper securing of helm is hazardous and can cause death or serious injury from sudden loss of control. Make sure the helm is secure before getting underway and during transporting the boat.**

### 2.2 Engine Throttle and Shift Controls

The shift and throttle controls on your boat may vary depending on the engines. The following control description is typical to most outboard remote controls. Refer to the engine or control manuals for specific information on the controls installed on your Pursuit.

The helm on your Pursuit is designed for a side mount control in single engine installations. Advancing the control lever beyond the shift range will advance throttle, forward or reverse. Each control is equipped to allow the engine to be operated above idle RPM while in neutral for cold starting or warming up.

### CAUTION

**Avoid possible injury or engine damage when shifting:**

- **Pause in neutral before shifting from FORWARD to REVERSE, or REVERSE to NEUTRAL.**
- **DO NOT shift into reverse while the boat is traveling forward at speed.**
- **Keep area around shifter control clear of obstructions.**

See your Pursuit dealer for necessary control. If the starter engages with the shift controls in any position other than neutral, the neutral safety switch is not functioning properly and must be repaired before using your boat.

### 2.3 Neutral Safety Switch

Every control has a neutral safety switch to prevent the engine from being started while in gear. Control adjustments must be performed if the engine will start in forward or reverse.

Test the neutral safety switch periodically to ensure they are operating. To test the neutral safety switch; tilt the engine down and move the shift lever to the forward position, past first detent. **DO NOT** advance past the idle position. Turn the ignition key to the start position. The starter should not engage. Repeat test with the shift lever in reverse and the engine throttle at idle, the starter should not engage. If the engine starts in gear during this test, immediately move the control lever to the neutral position and turn the engine off. Ejection or sudden loss of control can occur if an engine can start in gear and neutral safety switch system does not function properly.



**⚠ WARNING**

Test the neutral safety switch periodically. If the switch is not operating properly, **DO NOT** use the boat. Contact your Pursuit Dealer and have it repaired. An inoperable neutral safety switch can allow the engine to start in **FORWARD** or **REVERSE** causing sudden boat movement, throwing the operator and passengers off balance and possibly overboard.

**⚠ WARNING****LOSS OF CONTROL AND UNSAFE BOAT HAZARD**

A neutral safety switch that does not function properly can cause death or serious injury. **DO NOT** operate the boat if the switch does not function properly.

**2.4 Engine Power Tilt and Trim**

All outboard engines used on your boat have a tilt and trim feature. The tilt and trim switches are usually built into the engine shift and throttle controls and allow the operator to control the position of the outboards from the helm. Moving the gear cases closer to the boat transom is called trimming “in” or “down.” Moving the gear cases away from the boat transom is called trimming “out” or “up.” In most cases, the boat will perform best with the outboards adjusted so the hull will run at a three to five degree angle to the water.

The term “trim” generally refers to the adjustment of the outboards within the first 20 degree range of travel. This is the range used while operating your boat on plane. The term “tilt” refers to adjusting the outboards further up for shallow water operation, trailering or “tilting” the outboards out of the water. Refer to the engine owner’s manual for information on the proper use and maintenance of the power tilt and trim.

**⚠ CAUTION**

The outboard hoses and rigging or the transom gel coat can be damaged if the engine(s) are tilted to full up position or turned in the wrong direction. Turn the steering wheel completely to one direction or the other before tilting up to determined which direction is best for your boat.

**2.5 Engine Stop Switch**

Your Pursuit is equipped with an engine stop switch and lanyard. When the lanyard is pulled away, it will shut off the engine.

**⚠ WARNING****LOSS OF CONTROL AND UNSAFE BOAT HAZARD**

An engine stop switch system that does not function properly or is not used can cause death or serious injury. **DO NOT** operate the boat if the emergency stop switch system does not function properly.

Attach the engine stop switch lanyard to a strong piece of clothing on the operator. The engines will not start if the clip is not inserted into the stop switch. Make sure the lanyard is properly attached to the engine stop switch before attempting to start the engine.

**DO NOT** use the switch to stop the boat under normal operation. Test the switch periodically, if the switch is not operating properly, **DO NOT** use the boat. Contact your Pursuit Dealer and have it repaired.

The boat is provided with a spare engine stop switch lanyard. The spare lanyard allows the engine(s) to be re-armed in case of the primary lanyard becoming disconnected and lost or unreachable during boat operation. The spare lanyard is to be kept in a readily accessible location near the helm. If your boat is equipped with a stainless button-like post, snap the spare lanyard in place for secure and accessible storage.

Refer to the engine owner's manual for more information on the engine stop switch.



Engine Stop Switch (Typical)

## 2.6 Steering System

The steering system for the standard Pursuit Yamaha installed engine is electric. To activate the electric steering, insert the engine stop switch onto the binnacle. Turn the key switch to the ON position. This should allow the engine to be steered in any direction. The steering helm also includes a tilt helm mechanism. To tilt the helm, depress the lever located in the base of the helm and lock into position. DO NOT adjust the steering tilt helm when the boat is underway.

## Trim Tabs

The trim tabs are recessed into the hull on the transom. Switches are used to control the trim tabs. The switches are labeled to indicate the reaction of the bow of the boat. They control starboard and port up and down movements. Bow up and bow down will control the hull planning attitude, while port and starboard up and down provide control for the hull trim side to side.

Before leaving the dock, make sure that the tabs are in the full "UP" position by holding the control in the bow "UP" position for ten seconds. Do not continue to operate the switch when the tabs are fully up or down.

Establish the intended heading and cruise speed before attempting to adjust the hull attitude with the trim tabs. Always make slight adjustments to reduce over adjustments. After stabilizing speed and direction, move the trim tabs to achieve a level side to side running attitude being careful not to over trim.

After depressing a trim tab switch, always wait a few seconds for the change in the trim plane to take effect.

Avoid depressing the switch while awaiting the trim plane reaction. By the time the effect is noticeable the trim tab plane will have moved too far and the boat will be in an overcompensated position.

When running at a speed that will result in the boat falling off plane, lowering the tabs slightly, bow down, will improve the running angle and operating efficiency. Too much bow down tabs can reduce operating efficiency and cause difficult steering and handling.

When running at high speeds, make sure the tabs are in the full "UP" position. Only enough trim plane action should be used to compensate for any listing. Trim tabs are more sensitive at higher speeds. Adjust for this and be prepared to slow down if difficulties arise.

Be extremely careful when operating in a following sea. The effect of trim tabs is amplified under these conditions. Difficulty in steering and handling can result from improper trim tab usage, especially in a following sea; raise the tabs to the full bow "UP" position.

When running into a chop, a slight bow down attitude will improve the ride. Be careful not to over trim, difficulty in handling can result.

### Trim Tab Indicator



Lenco Trim Tab Switches

The switches are labeled to indicate the reaction of the bow of the boat. The L.E.D. displays indicate the position of the trim tabs. When adjusting the starboard bow up or down, the L.E.D. indicator on the right

side of the panel will activate, indicating the movement of the port tab. Refer to the trim tab operation manual.

### 2.7 Optional Electronics

If your boat is equipped with a factory installed electronics package care must be used when cleaning the acrylic trim panel. Use only soapy water with a soft, non-abrasive cloth to assure the best appearance.

#### NOTICE

**Use only warm soapy water and a soft, non-abrasive cloth to clean the acrylic electronics trim. Using any other chemicals or abrasive cloth will cause irreparable damage.**

### 2.8 Compass

The compass is located at the helm. To adjust the compass, read the instructions on "Compass Compensation" included in the literature packet. The compass cannot be adjusted accurately at the factory as it must be compensated for the influence of the electrical equipment and electronics unique to your boat. The compass should be adjusted by a professional after the electronics and additional electrical accessories are installed and before operating the boat.

### 2.9 Control Systems Maintenance

#### Control Maintenance

Periodic inspection of the control systems and all connections should be made. Signs of rust, corrosion, wear, or other deterioration must immediately be serviced. Periodic lubrication of all moving parts and connections with light waterproof grease is required.

Control system adjustments may become necessary. If adjustments are necessary, see your Pursuit Dealer.

## Steering System Maintenance

Periodically inspect the steering helm for signs of corrosion, cracking, loosening of fastenings. Excessive wear or deterioration must be corrected immediately. Check steering operation and visually inspect for loose or missing hardware before operating the boat. If you suspect the steering system is damaged, see your Pursuit dealer. **DO NOT** operate the boat if you suspect the steering system is malfunctioning.

### **WARNING**

#### **LOSS OF CONTROL AND UNSAFE BOAT HAZARD**

**Improper maintenance of steering system is hazardous and can cause death or serious injury from sudden loss of control. Make sure all steering hardware and fluid levels are regularly inspected and maintained.**

**DO NOT attempt to service any part of the steering system unless you are familiar or qualified to do so. Follow all instructions regarding maintenance procedures in the steering system owner's manual.**

## Trim Tab Maintenance

Marine growth can affect the operation of the trim tab planes and actuators. To help reduce marine growth, return the trim tabs to the full "UP" position after operating the boat. Inspect and clean the actuators and planes regularly.

The trim tabs also include a zinc anode to help prevent galvanic corrosion. Galvanic corrosion occurs when different metals are submerged in an electrolyte. Sea water is an electrolyte and submerged metal components must be protected. Anodes were factory installed and need to be replaced when they are 75% of their original size.

Refer to Routine Maintenance for information regarding zinc anodes and the trim tab owner's manual for additional maintenance information, fluid specifications and operating instructions.

**Operator Notes**

Lined area for operator notes, consisting of multiple horizontal lines.

## Fuel Systems

### 3.1 General

The fuel system of your Pursuit boat is designed to meet the requirements of the U.S. Coast Guard, Environmental Protection Agency (EPA), National Marine Manufacturers Association (NMMA), and American Boat and Yacht Council (ABYC) in effect at the time of manufacture.

All boats equipped with gasoline engines are required to have anti-siphon valves by the U.S. coast Guard.

DO NOT remove anti-siphon valves from system. Anti-siphon valves prevent fuel from flowing into the bilge should a fuel hose or fitting leak. If the valve becomes clogged, clean and reinstall or replace it.

Pursuit Boats has engineered an improved fuel tank fill and vent system that will reduce or eliminate fuel spillage when re-fuelling the boat with a standard automatic shut-off fuel fill nozzle provided by marinas and gas stations. This is in accordance to EPA regulations. While this system provides a clean consistent refueling experience, it still requires the operator's attention and must not be defeated by attempting to over-fill the tank with fuel. This system will automatically provide the proper air space (approximately 5% of total tank volume) in the fuel tank to accommodate the expansion of fuel during daily temperature cycles.

This new EPA compliant fuel system is engineered to vent through a carbon canister when the fuel cap is installed. This will greatly reduce fuel vapors that escape to the atmosphere and reduce the fuel odor that was present on traditional systems. For that reason, the fuel cap has been changed to help the operator verify the cap is properly closed.

The fuel system was factory inspected and pressure tested in accordance with regulations in effect at the time of manufacture. It is the responsibility of the boat owner to maintain the safe condition of the system.

Inspect the system frequently to ensure no deterioration or loosening of connections has occurred.

## DANGER

### FIRE/EXPLOSION HAZARD

Fuel and their vapors are highly explosive when exposed to open flame or spark, resulting in death or serious injury.

- Make sure no vapors are present before turning on electrical equipment or starting engines.
- Make sure fuel is added to the fuel tank only. DO NOT confuse other deck fills with fuel fills.
- DO NOT remove anti-siphon valves from the system.
- Turn off all electrical switches before servicing the fuel system.
- DO NOT drain any fuel in the bilge.
- Check all fuel lines and fittings for leaks before and after starting the engines and after any fuel system service.
- Prime fuel system and check all fittings for leaks before and after starting the engines.
- DO NOT block fuel vents.

DO NOT store fuel in any containers or compartments not designated for fuel storage.

## NOTICE

Certain bulkhead areas are sealed following U.S. Coast Guard regulations at the date of manufacture. Any modifications must be in accordance with the regulations.

### 3.2 Fuel System



**Fuel Valve**

The fuel system on your Pursuit boat has one fuel tank and is equipped with a manual “ON/OFF” fuel valve. Refer to the Schematics section. The fuel valve and tank fittings are accessed through deck plates on the cockpit deck surface. The valve is off when the handle is perpendicular to the fuel flow.

The fuel delivery line is equipped with an anti-siphon valve located where the line attaches to the fuel tank. This valve helps prevent gasoline from siphoning out of the fuel tank should a line rupture.

All boats equipped with gasoline engines are required to have anti-siphon valves by the U.S. Coast Guard. DO NOT remove anti-siphon valves from system. Anti-siphon valves prevent fuel from flowing into bilge should a fuel hose or fitting leak. If the valve becomes clogged, clean and reinstall or replace it.

#### Fuel Tank

The fuel pick-up tube is positioned in the tank to achieve optimum fuel usage, fuel line routing, etc. At certain speeds and hull trim angles, the fuel supply at the withdrawal tube can increase or decrease accordingly. Be extremely careful when attempting to operate the boat when low on fuel. Though some fuel may be in the tank, the trim angle of the boat may cause the fuel to flow away from the pickup tube.

#### Fuel Gauge Sender

The fuel gauge sender is more accurate when the boat is stationary and level. Because of the change in attitude when the boat is underway, variations in gauge readings can occur. This system is a relative indication of the available fuel supply and not a calibrated instrument.

#### Fuel Fill

A fuel fill is located on the port side gunwale and is marked “GAS.” The fuel fill is opened by turning it counterclockwise. After fueling, screw the cap on in a clockwise direction until an audible click is heard indicating that the cap is seated. If the cap is lost or damaged replace only with original equipment. During refueling the tank vents out at both the fuel fill plate and the vent located on the side of the hull. Note: There should not be any residual fuel at the vent but there could be residual fuel at the deck fill plate. Do not block or restrict either of these vents.

Fill the fuel tank slowly and monitor the fuel gauge while filling. Once fueling is completed wash the areas around the fuel fill(s) to help reduce discoloration of the fiberglass or striping. Use only the fuel recommended by the outboard manufacturer; refer to the engine owner’s manual for additional information.

If fuel is added to any other tank, DO NOT attempt to pump fuel out; these systems are not designed to pump fuel. Fuel must be removed by qualified personal only. Fuel in other systems will also require replacement of that system and/or many components.



EPA Fuel Fill



Fuel Filter

## Fuel Filter

The fuel filter is located in the aft mechanical space on the port side. The filter is the water separator type. Check the filter for water frequently to ensure an adequate supply of clean, dry fuel to the engine. The filter element should be changed once a season.

Turn off all electrical switches before servicing the fuel system and DO NOT drain any fuel into the bilge. Check all fuel lines and fittings for leaks before and after starting the engines and after any fuel system service. Prime fuel system and check all fittings for leaks before starting the engines.

## 3.3 Fueling Instructions

### **⚠ DANGER**

#### **FIRE/EXPLOSION HAZARD**

Gasoline vapors are highly explosive when exposed to open flame or spark, resulting in death or serious injury.

- Stop engines before fueling.
- DO NOT smoke or allow open flames or sparks nearby, within 50 ft (15 m) of the fueling area.
- Maintain contact between fuel nozzle and fuel tank fill to prevent electrostatic spark. DO NOT use a plastic funnel.
- Fill in an open area.

#### **BURN HAZARD**

Fuel floating on water which is ignited can cause death or serious injury. Fuel will float on top of water and can burn. If the boat is abandoned, swim upwind, far enough to avoid fuel that can spread over the surface of the water.

Try not to spill fuel. If fuel is spilled, wipe up all traces with dry rags and immediately dispose of the rags properly onshore. DO NOT allow fuel to stay on the finish of the boat, discolor and damage to trim can occur. Avoid fueling at night, except under well-lighted conditions. Also, monitor fuel level gauge to avoid overfilling.

### **NOTICE**

Use only the fuel recommended by the engine manufacturer. Use of old, contaminated fuel can cause the engine to malfunction or severe damage. Do not use fuel that contains more than 10% ethanol, harsh additives or methanol; damage to the engines and fuel system will result. Fuel system damage, related to use of alcohol-blended fuels, is not covered by the Pursuit Limited Warranty. Refer to the engine owner's manual for specific fuel requirements for your engines.



### To fill fuel:

1. Turn all switches to "OFF."
2. Secure boat.
3. Remove passengers from boat.
4. Extinguish all flame producing items.
5. Open fuel fill(s) by turning counterclockwise.
6. Put nozzle in the fuel fill opening.
7. The fuel delivery system will shut off when the tank is filled to the proper capacity.
8. Remove the nozzle.
9. Install and tighten fuel cap until it clicks.
10. Check the fuel compartment and below the deck for fuel odors. If you smell fuel, DO NOT start engines.

### DANGER

#### FIRE / EXPLOSION HAZARD

**Fuels are extremely flammable and highly explosive under certain conditions. DO NOT smoke or allow open flames or sparks nearby when inspecting the fuel system.**

**Frequently check fuel lines and all system components (filters, primer bulbs, clamps and connections) for leaks, damage or deterioration, or if you suspect damage, replace as necessary. Surface cracking on a hose indicates wear. Replace it.**

Spray the valves, fuel tank gauge sender and ground connections with a metal protector.

Inspect the fuel fill cap o-ring seals frequently and lubricate with petroleum jelly or silicone grease. The o-ring seal prevents water from entering the fuel system through the fuel fill cap. If the o-ring is damaged, or you suspect it is damaged, replace it.

Old, degraded gasoline can affect engine performance and damage the engine and boat fuel system. Chemical changes occur as gasoline ages, reducing octane and can cause deposits and varnish in the fuel system.

If your boat is not operated enough to require at least one full tank of fresh fuel a month, a fuel stabilizer should be added to

the gasoline to protect the fuel from degrading. Do not allow the boat to sit unused for an extended period with the fuel tanks less than 3/4 full. Changes in temperature and weather conditions can cause condensation in fuel tanks. Your Pursuit dealer or the engine manufacturer can provide additional information on fuel degrading and fuel stabilizers recommended for your engine.

Improper storage of fuel at marinas, limited boat usage, etc. can cause the fuel to become contaminated. Periodically, it may be necessary to pump accumulating water and contaminated fuel from the bottom of the fuel tanks. If the fuel system on your boat becomes contaminated, contact your dealer or marina for assistance.

Avoid using fuels with alcohol additives. Alcohol blend gasoline will absorb moisture from the air which can reach such concentrations that "phase separation" can occur where the water and alcohol mixture becomes heavy enough to settle out of the gasoline to the bottom of the tank. Since the fuel pickup tubes are near the bottom of the tank, phase separation can cause the engine to run very poorly or not at all. Phase separation is more severe with methyl alcohol and will increase as the alcohol content increases. Water or a jelly like substance in the fuel filters is an indication of phase separation from the use of alcohol blended fuels.

## Electrical Systems

### 4.1 General

Your Pursuit boat is equipped with a 12 volt DC electrical system. The DC system draws current from onboard batteries.

Electrical schematics are included in this manual to assist technicians in the servicing the electrical systems. Pursuit recommends you take your boat to an authorized Pursuit dealer for service or installation of additional electrical equipment. Pursuit reserves the right to modify or update the electrical system at any time without notice to the consumer or obligation to make updates to boats built prior to the change.

Some compartments on your boat may be lighted. Lights bulbs produce heat and can ignite combustible products. Turn off all lighting before you leave the boat.

### **WARNING**

**FIRE OR EXPLOSION HAZARD**  
Ignited combustible products can cause fire or explosion, resulting in death or serious injury. **DO NOT** store combustibles near lights and turn off all lighting before leaving the boat.

### 4.2 DC System

#### Batteries

The 12-volt batteries have been selected to provide optimum performance for engine starting, and house and electronics loads. There are two, group 27 (Yamaha 300). These batteries require similar maintenance to automobile batteries. The batteries are located in the aft bilge. The starboard battery is reserved for engine starting and the port battery is the house battery. A circuit breaker on the engine protects the engine ignition systems and gauges. Refer to the engine owner's manual for information on the circuit breakers installed on your engines.

#### DC Distribution

The 12-volt DC system is made up of batteries that are charged by the engine charging system. Boats that are factory rigged with Yamaha® engines utilize the Yamaha Battery Isolator to charge the engine cranking battery and the house battery. The 12-volt DC power is distributed to the battery switches and the circuit breakers on the Main Distribution Panel (MDP), located on the starboard side of the cockpit. These circuit breakers protect the switches that are located on the helm and in the head enclosure.

The circuit breaker on the engine protects the engine ignition systems and gauges. Refer to the engine owner's manual for information on your engines.

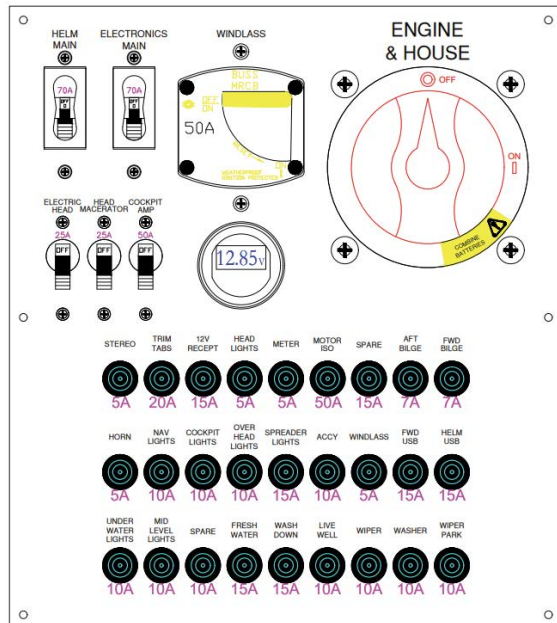

**Main Distribution Panel DC246**

## Battery Switches

A single battery switch controls the engine and house batteries. The engine and house batteries can be paralleled by switching the battery switch to "combine batteries." Current is supplied to the automatic float switch for the bilge pump, and the stereo memory, when the batteries are connected and the battery switches are "OFF".

### NOTICE

**DO NOT** operate the boat with the engine battery switch in the combine batteries position.

## 4.3 Main Breakers/Helm Electronics

### Electronics Main

This is reserved for electronic accessories installation. An electronic bus is located behind the helm.

### Helm Main

Supplies the 12-volt current to helm panel.

### Electric Head

Supplies the 12-volt current to the optional electric head and the head control panel.

### Macerator

Supplies the 12-volt current to the head macerator pump included in the electric head option.

### Cockpit AMP

Supplies the 12-volt current to the amplifier included the base and upgraded stereo options.

### Other Breakers

All remaining devices and circuits are protected by "PUSH to reset" breakers that are normally in the ON position. If a breaker trips, reset by pressing the plunger. Each breaker is labeled with the name of the device it protects.

The stereo memory and aft bilge pump are always ON.

Bilge pumps and bilge pumping systems are not designed for damage control. Make sure all bilge pumps are functioning at regular intervals. Debris can also prevent the pumps from functioning or operate continuously. Make sure no debris is blocking the bilge pump float(s).

Breakers also protect the engine charging isolator wiring. If you experience a battery-charging problem, check the engine isolator breakers and reset as necessary.

## 4.4 12-Volt DC Panel

### Helm Panel

The following are descriptions of the components controlled by the helm switches:

#### Horn

Press to activate the horn.

#### Nav/Anc

Press the top of the rocker switch to activate the navigation lights. Press the bottom of the rocker switch to activate the anchor light.

### Cockpit

Press to activate the lights that illuminate the cockpit area.

### Overhead Lights

Press to activate the lights mounted underneath the hardtop. Press once and the lights are red; press again and the lights are bright white; press a third time and the lights are blue. If lights get out of sequence, press the switch and hold for two seconds.

### Spreader

Press to activate the flood lights located on the hardtop.



DC 246 Helm Switch Panel Diagram

### Wiper

Press to activate the windshield wiper.

### Washer

Press to activate the windshield washer solenoid. The windshield washer draws fresh water from the fresh-water tank.

### Mid Level Lighting

Press to activate the mid level lighting under gunnels.

### Under Water Lights (Optional)

Press to activate the under water lights.

#### **NOTICE**

**Under water lights are designed to be used only when in the water. Leaving them on when out of the water can cause permanent damage to the lights.**

### Aft Bilge

Press to activate the manual pump.

### Fwd. Bilge

Press to activate the forward bilge pump.

### Fresh Water

Press to activate the fresh water pump.

### Washdown

Press to activate the raw water washdown pump. The pump is a pressure demand type and is protected by a circuit breaker on the MDP and an automatic reset breaker in the pump motor.

### Livewell

Press to activate the livewell circulation pump to supply water to the livewell. The pump is protected by a circuit breaker on the helm panel and an automatic reset breaker in the pump motor.

### ACC

This is an open switch and reserved for future additional accessories. DO NOT exceed 10 amps.

## 4.5 Electrical System Maintenance

### 12-Volt DC Electrical System Maintenance

Semi-annually spray all exposed electrical components behind the helm and in the plugs with a protector specific for electrical connections.

Make sure to check that all below deck wiring is properly supported, the insulation is sound and there are no loose or corroded terminals. Clean any corroded terminals thoroughly with sandpaper, or replace them. Tighten securely and spray with a metal and electrical protector. Inspect all engine wiring.

Check the electrolyte level in the batteries regularly and add distilled water as necessary. If the batteries are frequently charged by a battery charger, check the electrolyte level more often. The correct fluid level in the cells is approximately  $\frac{1}{4}$  to  $\frac{1}{2}$  inch above the plates. If fluid is needed, fill to the proper level with distilled water **ONLY**. **DO NOT** overfill. Some batteries are sealed and cannot be filled.

Keep the tops of any battery clean and dry. Dirt and water can conduct electricity from one post to the other and can cause battery discharge or cause errant engine warnings.

Keep the battery posts free of corrosion. **DO NOT** use wing nuts to attach battery cables. Remove the cables and clean the posts and cable clamps with a battery post cleaner or sandpaper as required. Coating the battery posts and cable clamps with petroleum jelly or silicone grease will help protect and reduce corrosion. Battery cables, both positive and ground must be replaced when they show signs of corrosion or fraying. Deteriorated cables cause a considerable voltage loss when high currents are drawn, as for starting the engine.

### **DANGER**

#### **FIRE OR EXPLOSION HAZARD**

**Explosion or fire from hydrogen gases produced by lead acid batteries will cause death or serious injury. DO NOT smoke or bring a flame near battery storage area. If ignited by a spark or flame, gas may explode violently, causing spraying of battery acid or fragmentation of the battery.**



## Plumbing System

### 5.1 Fresh Water System

#### General

The fresh water system consists of a potable water tank, distribution lines and a distribution pump. The pump is equipped with an automatic pressure switch and is located in front of the close out panel in the mid-ship in floor hatch. To access remove the mounting screws and lower the panel. An in-line strainer located near the pump protects the system from debris. The tank is filled through a labeled deck fill located in the port side head unit.

DO NOT confuse other deck fill with fresh water fill. If toxic fluids or fuel is added to fresh water tank, the system will be contaminated. DO NOT attempt to pump fuel out; this system is not designed to pump fuel. Fuel must be removed by qualified personnel only. Fuel in the fresh water systems will also require replacement of that system and/or many components.

#### DANGER

**FIRE OR EXPLOSION HAZARD**  
Fuel and their vapors are highly explosive when exposed to open flame or spark, resulting in death or serious injury. Do not confuse deck fills.

#### WARNING

**DISINFECT THE ENTIRE FRESH (POTABLE) WATER SYSTEM PRIOR TO USE AND YEARLY AT THE BEGINNING OF EACH SEASON. FAILURE TO DO SO CAN RESULT IN DEVELOPING COLIFORM BACTERIA OR OTHER DISEASE-CAUSING ORGANISMS (PATHOGENS) IN THE WATER SYSTEM. CONSUMPTION OF CONTAMINATED WATER COULD RESULT IN SEVERE PERSONAL INJURY OR DEATH.**

#### Operation

Before using the fresh water system for the first time or for the first time each season follow the commissioning process in the appendix section of this manual. Fill the water supply tank slowly through the FRESH WATER FILL deck plate. After filling tank, partially open all faucets. Turn on "Fresh Water System" switch at the helm. Allow the pump to run until all of the air is purged from the system and a steady stream of water is flowing from each outlet. Next, turn off the faucets one by one. As the pressure builds, the pump will automatically shut off.

When properly primed and activated, the water system will operate like the water system in a home. An automatic pressure sensor keeps the system pressurized. If the system has been recently filled or has not been used for an extended period, air may accumulate at the pump and the system may have to be re-primed.

Whenever the boat is left unattended, turn the fresh water system switch "OFF."

#### NOTICE

**DO NOT allow the fresh water pump to run dry; damage to the pump can occur. The fresh water pump works on demand and WILL NOT shut off when the tank is empty. Turn the water pump switch "OFF" when the system is not in use. Operating any pump from a low-charged battery can lead to a pump failure. Keep the batteries properly charged. The fresh water system must be properly winterized prior to winter lay-up. Refer to Winterizing.**

### 5.2 Raw Water Washdown

The raw water washdown system pump is supplied by hoses connected to a ball valve and a thru-hull fitting located in the bilge.



### Operation

Make sure the ball valve is open before attempting to operate the raw water washdown system. The pump is activated by the Raw Water switch located on the helm. When activated, the pressure switch will automatically control the pump. As pressure builds in the washdown hose, the pump will shut off. When the washdown hose is in use and the pressure drops, the pump will turn on. Turn the switch off when the washdown is not in use. The raw water washdown pump is equipped with a small in line strainer on the intake side of the pump, located in the aft bilge; check it frequently and clean as necessary.



Washdown Hose Connector

### Priming the System

Open the ball valve and hose connector, and activate the pressure pump. Run the pump until all air is purged from the system. Close the thru-hull ball valve before the boat is hauled from the water to eliminate an air lock in the system. It may be necessary to re-prime the raw water system if the system is not used for an extended period.

### NOTICE

**DO NOT operate high-pressure pump dry, damage to pump will result. Turn the raw water pump switch "OFF" when leaving the boat unattended.**

### 5.3 Livewell

Seawater is provided to the livewell by a 12-volt pressure pump. The pump is activated by the Livewell/Washdown switch on the helm. An overflow built into the livewell automatically controls livewell water level. Always turn livewell pump off at the switch panel when not in use.

To fill the livewell, insert the plug into the drain fitting at the bottom of the livewell. Make sure the ball valve at the intake thru-hull fitting is open and turn on livewell pump. When water level reaches the overflow, it will begin to circulate.

To drain, turn off pump and remove plug. When the livewell has drained, use the washdown hose to flush livewell and drain debris.

Close the livewell thru-hull ball valve whenever livewell is not in use to prevent water from entering the livewell while the boat is cruising.

Do not use livewell for stowage. Seawater can possibly enter the livewell when it is not in use and damage stowed equipment.

### 5.4 Drainage

#### General

Some drain thru-hull fittings are equipped with ball valves that are always open under normal operating conditions. In the event of an emergency, close the valves to prevent sea water from entering the boat through the drainage system. Check and operate the drain valves at least once a month to make sure they are in good condition and operating properly. Also, check the drain system to

ensure it is free flowing and hoses on the thru-hull fittings are secure and not leaking.

Review and become familiar with the drainage system and location of the thru-hull drain valves. Access to these valves are through the aft mechanical hatch, aft portholes behind the transom wall and mid ship within the access panel in the head unit.

A situation requiring one or more drain valves to be closed can be dangerous to boat and all onboard. If this occurs, distribute PFD's and take all necessary safety precautions, including notifying the Coast Guard or local agency, until the problem is determined and corrected.

## Bilge Drainage

There are two bilge pumps located in the bilge. The aft pump is located near the transom on centerline. The forward pump is located within the mid ship access hatch. All bilge pumps pump water out of thru-hulls located above the waterline in the hull. See Electrical Systems for additional information on bilge pump operation.



**DC 246 1000 GPH Bilge Pump**

Test the bilge pumps at regular intervals. Debris can prevent the pump from operating or make it operate continuously. Make sure no debris is blocking the bilge pumps and the surrounding areas.

Bilge pumps and bilge pumping systems are not designed for damage control. Continuous operation of the bilge pumps can mean a leak or a drain plug is installed incorrectly; make sure all drain plugs are installed.

Excess water in the bilge area will adversely affect the handling and maneuverability of the boat and can cause personal injury. DO NOT allow the bilge pump to operate after all the water has been cleared from the bilge area. Damage to the pump will occur.

Current is supplied to the automatic pump whenever the batteries are connected. The bilge pump switch in the helm is supplied current when the house battery switch is in the "ON" position. Breakers for both the manual and the automatic functions are located on the MDP.

Activate the manual bilge pump briefly each time the boat is used to ensure pump is operating properly. Activate the automatic switch manually to verify operation by spraying water in the aft bilge until the automatic switch activates the pump. There is a delay built into the switch before the pump will activate. The pump will continue to operate for a short time after the water is removed. Refer to the bilge pump manufacturer's information under "Plumbing" for more information.

When the boat is out of the water, the bilge can be drained by a thru-hull drain located in the transom, near the bottom of the hull. It is important to check the drain plug regularly to make sure it is tight.

A loose drain plug will allow sea water to enter the bilge and cause the boat to sink. Check the drain plug frequently to make sure it is secure.

Any oil spilled in the bilge must be thoroughly removed and properly disposed of before operating the bilge pump. The discharge of oil from the bilge is illegal and subject to fine.

**NOTICE**

The federal water pollution control act prohibits the discharge of oil or oily waste into or upon the navigable waters of the United States or the waters of the contiguous zone if such discharge causes a film or sheen upon, or a discoloration of the surface of the water, or causes a sludge or emulsion beneath the surface of the water. Violators are subject to a penalty of \$10,000.

**Exterior Drains**

Your Pursuit boat has two scupper drains located in the rear of the cockpit. The drain rails for the mechanical space drain overboard by gravity.

All exterior sinks and livewells, provided with fresh or raw water, drain by gravity to overboard thru-hulls.

The storage compartments, located in the bow, drain overboard.

The rope locker drains overboard through a special drain fitting located in the hull side at the bottom of the rope locker. Inspect the drain frequently to remove any accumulated debris.

**5.5 Plumbing System Maintenance**

Information supplied with water system components, by the equipment manufacturers, is included with this manual. Refer to the information for additional operation and service information.

**Fresh Water System****NOTICE**

Turn the fresh water system switch "OFF" when leaving the boat unattended or when the fresh water system is not in use.

Perform these routine maintenance procedures to maintain your fresh water system:

- Remove filter screens from faucet spouts and eliminate any accumulation of debris. A debris build-up can cause the pump to cycle excessively.
- Check and clean the fresh water system strainer located on the intake line near the pump at least annually.

**NOTICE**

Maintain a proper charge on the batteries. Operating the pressure pump from a battery with a low charge could lead to pump failure.

- Add a commercially available potable water conditioner to the water tank to keep it fresh.
- Make sure the fresh water system switch is "OFF" when leaving the boat unattended or when not in use.

**Raw Water System****NOTICE**

If a hose ruptures, turn pump off immediately. Close the thru-hull valve before performing maintenance on sea water pump. Operating any pump from a low-charged battery can lead to a pump failure. Keep the batteries properly charged. The raw water system must be properly winterized prior to winter lay-up. Refer to Winterizing.

Perform these routine maintenance procedures to maintain your raw water system:

- Check hoses for signs of deterioration, especially the sea water hoses.
- Spray pumps and thru-hull valves with a metal protector periodically.
- Drain and clean the livewell after each use.
- Operate all thru-hull valves at least once a month to keep them operating properly.

If a hose ruptures or leaks, turn off pump immediately. Keep the thru-hull valve closed when performing service on a sea water system.

- Operate the thru-hull valves once a month and service as required.
- Check the drain system regularly to ensure it is free flowing and hoses on the thru-hull fittings are secure and not leaking.

## NOTICE

**DO NOT use harsh chemical drain cleaners in drain systems; permanent damage to the hoses, fittings and system can result. Also, drains and pumps must be properly winterized before winter lay-up.**

## NOTICE

**Maintain a proper charge on the batteries; operating the pressure pump from a battery with a low charge could lead to pump failure.**

The fresh and raw water systems must be winterized properly before storage. Refer to Winterizing.

## Drainage Systems

Perform these routine maintenance procedures to maintain your drainage system:

- Clean the cockpit drain rails with a hose and water to remove all debris.
- Clean the hardtop leg drain holes, especially before winter storage.
- Check the bilge for debris that can block the function of bilge pumps.
- Test rear automatic bilge pump switch each time the boat is used, for proper operation. Add water to the mid bilge until the water level is high enough to activate the forward automatic bilge pump.
- Flush all gravity drains with fresh water to keep them clean and free flowing.
- Clean and flush cooler/storage boxes with a mild soap or a bilge cleaner and fresh water after each use to keep them clean and fresh.



## Ventilation System

### 6.1 Carbon Monoxide and Proper Ventilation

Proper ventilation should be maintained through the cockpit area by opening the windshield center window or the weather door.

Read "Carbon Monoxide" in the Safety Section. It contains important information on carbon monoxide and the carbon monoxide detector.



## Exterior Equipment

### 7.1 Deck

#### **⚠ CAUTION**

Unsecured open exterior doors and/or hatches can slam closed and cause injury or damage the boat. Most doors and hatches are equipped with fasteners, hatch lifters, snaps and/or straps to secure them open make sure they are properly secured while they are open.

#### Rails and Deck Hardware

Rails and deck hardware perform specific functions. Do not use for securing fenders or mooring lines; these must be secured to the cleats. Make sure mooring lines are clear of rails or stanchion, or damage can result.

Some cleats are flush mount and must be raised prior to use.

DO NOT use cleats or any other hardware for the purpose of towing or being towed. Inspect all hardware periodically for loosening, wear or damage. Repair or replace immediately.

#### Anchor/Rope Locker

The anchor locker at the bow of the boat can be accessed through the deck hatch. The anchor locker is drained by a thru-hull fitting in the hull side near the bottom of the locker. Check it frequently and keep it clean and free flowing.

Secure anchor chain when trailering or while underway.

#### **NOTICE**

Secure anchor when it is stored in its locker and make sure it does not rest against the hull sides. If the anchor is loose, it will bounce and damage the boat. Damage from anchor bouncing in the locker is not covered by the Pursuit warranty.

#### Windlass (Optional)

#### **NOTICE**

DO NOT use windlass as the only method of securing anchor in the bow roller. Secure anchor line to a cleat or chain snubber before trailering or operating your boat.

#### **⚠ WARNING**

**MOVING PARTS OR ENTANGLEMENT HAZARD**  
Contact with moving parts can entangle, cut, resulting in loss of body parts, strangulation and/or severe loss of blood, causing serious injury or death. Stay clear of moving parts.



DC 235 Windlass Option



The windlass is located under the forward deck hatch above the rope locker. The anchor is stored on the anchor roller and is raised and lowered by the windlass. The anchor line is stored in the rope locker and routed out through the windlass to the anchor chain and anchor. The anchor locker is equipped with a receptacle for the windlass remote control.

Become familiar with the safe operation of the windlass before using it. Refer to the windlass owner's manual for the use of the windlass and remote control.

The anchor is lowered by releasing the anchor from the cleat or chain snubber on the pulpit and activating the deploy switch on the anchor windlass remote hand held switch. After the anchor is set, do not allow the windlass to take the force from the anchor line; secure the anchor line to the anchor line cleat.

The anchor is retrieved by releasing the line from the bow cleat and activating the retrieve switch on the anchor windlass remote hand held switch. When the chain begins to enter the windlass gypsy, release the switch. Jog the switch to start and stop the windlass, to allow the anchor to properly seat for stowage in the anchor roller. Inspect the anchor to ensure it is stowed correctly, with the plow/flukes down so the anchor will not contact the hull. Once the anchor is stowed, secure the anchor to the chain snubber or bow cleat to prevent it from releasing while underway.

Boats at anchor in high swell conditions will snub on the anchor line. This can cause slippage or apply excessive loads to the windlass.

DO NOT use the windlass as a winch to move the boat over the anchor. Move the boat under its own power to the anchor to break the anchor loose.

### Windshield

The DC 235 is equipped with an opening, heavy duty, fiberglass windshield. The front and side wing panels are tempered safety glass.

The vent window is provided with locks that secure the window in the open and closed position. The security of the vent window should always be verified before getting underway.

#### CAUTION

**To prevent injury or damage to the vent window or windshield the vent window must be secured when in either the open or closed position.**

The vent window glazing can be replaced, similar to replacing automotive windshields.

### 7.2 Cockpit

#### Boarding Platforms

Your Pursuit boat is equipped with port and starboard aft integrated boarding platforms. A foldaway boarding ladder is located in the aft starboard corner of the boarding platform. DO NOT use the boarding platforms or ladder while an engine is running. The engines must be "OFF" before allowing anyone to enter or exit the boat or when they are in the water. Stow ladder before starting an engine.

#### DANGER

**CARBON MONOXIDE POISONING AND/OR ROTATING PARTS HAZARD**  
Poisonous CO gases are present at the rear of the boat when an engine is running. A rotating propeller can cut or entangle swimmers. Both of these hazards will cause death or serious injury. DO NOT use the swim/boarding platform when the engine is running.

## Transom Door

Do not use the transom door when the boat is in motion. DO NOT leave the transom door unlatched. Latch it in the full "OPEN" or full "CLOSED" position.

### **WARNING**

#### **UNSAFE BOAT HAZARD**

**Failure to close and secure transom door/gate while underway can expose passengers to rotating propellers, throw them overboard or swamp the boat which can cause death or serious injury. Close and secure door/gate before getting underway.**

### **NOTICE**

**Inspect transom door/gate fittings periodically for wear, damage or loose fit. Repair or replace before using your boat.**

## Foldout Bench Seat

The aft bench seat is hinged and opens to provide additional seating space. To open, grasp both handles and pull away from the transom. The seat will lock into its horizontal position. To stow, lift the forward edge with the handles and push towards the transom.

The mechanical space is located under the foldout seat. It is accessed by removing the mechanical space hatch. Care must be taken when replacing this hatch. The angled section of gasket on the underside of the hatch must line up with the angled corners of the opening. Failure to align them could end up in excess water entering the bilge.

### **CAUTION**

**Keep hands away from the seat mechanism when opening and closing. Injury could occur.**

## Ski Tow Pylon

The optional ski tow pylon is designed for a single water skier only. The ski tow is not to be used for anything other than water sports.

### **DANGER**

**Do not overload the ski pylon. The maximum load is 1000 lbs. (454 kg).**

Use caution with towing a skier as the tow rope may backlash into the cockpit when released or should the line fail, resulting in injury.

## Bow Seating and Storage

There are two storage compartments located in the bow. The port and starboard compartments are equipped with cushions and backrests to provide comfort while in a seated position. Storage is directly underneath and can be accessed by lifting the forward edge of the seat cushions to their full upright position.

The third compartment is located in the cockpit sole is designed for ski storage. Access to the holding tank is provided through this compartment.

## Optional Hardtop

The optional fiberglass hardtop frame is white powder coated aluminum and is designed to accommodate radio antennas, radar antennas and navigation lights. It is equipped with overhead red and white lights and can be equipped with optional outriggers and/or rod holders.

**NOTICE**

Care should be exercised to prevent damage to powder coated surfaces. If the surface is scratched, chipped or worn exposing the aluminum, it should be resealed to prevent corrosion from forming. If corrosion is allowed to form, it could cause the powder coating to bubble and lift away. Contact your dealer for repair service.

The hardtop is not designed to support the additional weight of items like an instrument locker or a life raft. Radar and electronics antennas must be mounted to the top between the front and rear legs. Do not mount any antennas or equipment to the brow area. The hardtop frame is not designed to support the weight of accessories in this area and can be damaged. The starboard rear leg provides the chase for components mounted to the top.

The hardtop warranty will be voided if the top is modified in any way or heavy accessories are mounted to the top. Also, if items like radar antennas, spotlights and other accessories are mounted in the wrong location, the warranty can be voided. If you intend to add equipment or make modifications to the hardtop, contact Pursuit Customer Relations to make sure the equipment you would like to add or the intended modification will not void the warranty on the top.

There is a hole drilled in each of the leg bases to prevent water from being trapped within the leg and provide wire routing for accessories. A smaller hole is drilled in the tubing at the base of the other legs is to allow water to drain only. Keep the hardtop leg drains clean, especially before winter lay-up.

**Hardtop Canvas (Optional)**

Because the aluminum frames vary slightly, the side curtains and front curtain are custom made to each boat at the factory. Slide the side curtains, first, then the front curtain into the slide tracks on the windshield and hardtop. Start the zippers, but DO NOT zip closed. Snap the side curtains to the deck and then the hardtop legs. The side curtains will have to be stretched slightly to pull out the wrinkles and reach the snaps. Once the curtains are snapped in place, close the zippers.

If you have an optional aft cockpit cover, slide it into the track on the back of the hardtop and start but don't close the zippers that join it to the side curtains, snap the aft curtain to the deck and close the zippers. A support pole is provided to prevent a low spot that would cause water to puddle in the cover.

Cold weather can make the clear vinyl material on the curtains stiff and difficult to stretch to the snaps. This can be particularly difficult with new canvas that has been stored off the boat. Lay the curtains in the sun for 30 minutes during the heat of the day to make installation easier in cold weather.

**Optional Bimini Top (Optional)**

The canvas for Pursuit boats is custom fit to each boat. The optional bimini top is designed with a relatively flat profile and a snug fit.

To install the Bimini top, attach the main legs to the deck hinges using the quick release pins and leave the rear stanchions loose. Next, open the bimini and attach the front stanchion to the deck hinge on the top of the windshield frame. Attach the rear stanchions, one at a time, to the rear deck hinges located near the rear of the windshield. Use your body weight on the rear corner of the bimini to pull down and stretch the fabric until the stanchion eye end lines up with the hole in the deck hinge. Secure each eye end to the deck hinge with the quick release pins. If the top is still adjusted to factory specifications, the top will be level and the main legs will have a visible bow in them.

To install the side curtains and front connector start with the side curtains. Slide them into the tracks on the windshield. Slide each section of the front connector into the windshield. Start the zippers but don't close them. Snap the side curtains in place and close all of the zippers. If the bimini is adjusted properly, the side curtains will have to be stretched slightly to pull out the wrinkles and reach the snaps. The main load for the top should remain on the front and the rear stanchions. Attach the aft curtain to the zipper on the back of the bimini and to the side curtains. Snap the curtain to the deck and cockpit.

The optional tonneau cover is installed starting the snaps at the bow and working around each side to the windshield. The center section attaches to the window with snaps.

**Note:** Cool weather can make the clear vinyl material stiff and difficult to stretch to the snaps. This can be particularly difficult with new canvas that has been stored off the boat. Laying the curtains in the sun for 30 minutes during the heat of the day will make installing them much easier in cold weather.



## Interior Equipment

### 8.1 Port Console

#### Portable Toilet (Standard)

The toilet is standard equipment on the DC246. The system is made up of three major components, the head unit itself, the fresh water tank and holding tank.

To use the toilet, add the recommended amount of holding tank deodorant to the waste tank and fill the water supply. To flush after use, pull the waste valve handle straight out, then press the flushing bellows one or more times to rinse. To close and seal the waste holding tank, simply push the valve handle all the way in. Monitor the level in the waste tank and empty as necessary.

To keep your toilet operating properly it must be emptied and properly cleaned periodically.

#### Maintenance

Clean and inspect the head for leaks regularly. Refer to the head owner's manual for additional operating and maintenance information.

#### **NOTICE**

**The head system must be winterized before winter lay-up; refer to Winterizing.**

#### Electric Marine Head System (Option)

Your boat is equipped with an electric marine head system as an option. The system uses a small amount of fresh water and an electric flush motor to flush. The motor is part of the self-contained head. The head is connected to the pressurized fresh water system. Fresh water is used to reduce odor in the head compartment.

To use the head, make sure the ELECTRIC HEAD breaker on the MDP is turned on. To add water to the bowl, press and hold the WATER ONLY button on the Smart Toilet Control (STC) panel. The inlet water solenoid/pump runs if the button is pressed with an eight second limit. After the limit is reached, this button is disabled to prevent overflow of the bowl. To enable again, the EMPTY ONLY button must be pressed. The WATER SAVER button has only one cycle of inlet and discharge to clear liquid waste. The last fill is to retain water in the bowl for next use. The NORMAL FLUSH button activates a timed flushing cycle. There are three cycles of inlet and discharge. The first cycle removes most of the waste. Second cycle removes remaining waste if any left after first cycle. Third cycle clears all discharge housing and lines with clean water. Last fill is to retain water in the bowl for next use.

The STC panel offers two different flush modes to choose from. They are Sequential Flush and Continuous Flush. The head is preprogrammed to follow the sequential flush operation. The fill/empty cycle will repeat once in WATER SAVER and three times during the NORMAL FLUSH cycle. At the end of this sequential cycle, a short pause will be followed by a final fill to leave water remaining in the bowl. In the Continuous Flush mode, the head will add water to wet the bowl first and then follow with the inlet and discharge motors flushing together for the remainder of the cycle. Refer to the head owner's manual for the procedure for changing the flush mode for Sequential to Continuous and vice versa.

The waste is directed to the holding tank until it is pumped out by a waste dumping station or the overboard macerator discharge system.

**NOTICE**

**DO NOT** operate the macerator dry; damage to the pump can occur.

In some waters it is illegal to discharge waste overboard. Remove the seacock handle or use another method to prevent accidental discharge.

**Holding Tank and Macerator Discharge Pump**

Waste is pumped into the holding tank where it remains until it is pumped out at a waste dumping station or the overboard macerator discharge system.

The holding tank is under the deck, in the forward storage compartment. When the tank is full it must either be pumped out by an approved waste dumping station through the waste deck fitting or be pumped overboard with the macerator discharge pump, following the proper overboard dumping regulations when legal to do so.

To operate the macerator discharge pump, open the discharge ball valve, located in the forward storage compartment. Then activate the macerator switch, located on the switch panel in the head. When the tank is emptied, release the switch.

**8.2 Audio and Video Systems****Stereo**

The stereo is a 2 part unit made up of a water resistant head and a tuner/amplifier section mounted behind the helm. It has the capability to incorporate an USB jack, if so desired.

## Safety Equipment

### 9.1 General

Your boat and outboard engines have been equipped with safety equipment designed to enhance the safe operation of the boat and to meet U.S. Coast Guard safety standards. The Coast Guard or state, county, and municipal law enforcement agencies require certain additional accessory safety equipment on each boat. This equipment varies according to length and type of boat and type of propulsion. Most of the accessory equipment required by the Coast Guard is described in this Section. Some local laws require additional equipment. It is important to obtain "Federal Requirements And Safety Tips for Recreational Boats," published by the Coast Guard, and copies of state and local laws, to make sure you have the required equipment for your boating area. You should also read the book entitled "Sportfish, Cruisers, Yachts - Owner's Manual".

Your Pursuit boat could be equipped with engine alarms and cabin monitoring equipment. These systems are designed to increase your boating safety by alerting you to potentially serious problems in the primary power systems, the engine compartment and the cabin. Alarm systems are not intended to lessen or replace good maintenance and "Pre-Cruise System Check."

This Section also describes safety related equipment that could be installed on your boat. This equipment will vary depending on the type of engines and other options installed by you or your dealer.

### 9.2 Engine Alarms

Most outboards are equipped with an audible alarm system mounted in the helm area that monitors selected critical engine systems. The alarm will sound if one of these systems begins to fail. Refer to the engine owner's manual for information on the alarms installed with your engines and additional operating and maintenance information.

If the alarms sounds:

- throttle the engines back to idle immediately.
- shift to neutral.
- monitor the engine gauges to determine the cause of the problem.
- if necessary, shut off the engines and investigate until the cause of the problem is found.
- if the boat is equipped with water sensors in the fuel filters, make sure to check them for excessive water.

### 9.3 Neutral Safety Switch

Every throttle/shift control system has a neutral safety switch. The switch allows the engines to be started in NEUTRAL only. If engines will not start, make sure controls are in NEUTRAL. Control or cable adjustments may be required to correct this condition should it persist. See your Pursuit Dealer for necessary control adjustments. Refer to the Helm Systems for more information on the neutral safety switch.

### 9.4 Engine Stop Switch

Your Pursuit boat is equipped with an engine stop switch, clip and lanyard. When the lanyard is pulled, it will shut off the engines.

#### **WARNING**

#### **LOSS OF CONTROL AND UNSAFE BOAT HAZARD**

**An engine stop switch system that is not used or does not function correctly can cause death or serious injury. DO NOT operate the boat if the stop switch system does not function properly.**

The stop switch will stop an engine whenever the lanyard is pulled far enough to disconnect the clip from the switch. Attach the lanyard to the boat operator whenever an engine is running, but be aware of loss of engine power if the switch is activated.



If the operator is thrown from the seat, or moves too far from the helm, the lanyard will disconnect the clip from the switch, shutting off the engine.

To attach a lanyard, connect the clip to the emergency stop switch and the hook to a strong piece of clothing on the operator, such as a belt loop.

If the engines will not start, the clip may not be inserted into the engine stop switch properly or the control is not in neutral. Make sure the clip is properly attached to the engine stop switch before attempting to start the engine.

Always carry a spare stop switch clip and lanyard and instruct at least one other person onboard the operation of the stop switch and location of the spare.

### **WARNING**

#### **FIRE/EXPLOSION HAZARD**

The gas of the fire extinguisher system displaces oxygen to “smother” the fire. **DO NOT** open the hatch. Oxygen can feed a fire and flashback can occur which can cause death or serious injury. If the onboard fire system discharges, wait at least 15 minutes before opening engine hatch.

## 9.5 Carbon Monoxide Hazards

### **DANGER**

#### **CARBON MONOXIDE HAZARD**

Exposure to CO will cause death or serious injury. CO is colorless, odorless and extremely dangerous. Avoid CO exposure and make sure the CO detector is working properly.

Carbon monoxide (CO) poisoning is lethal and should not be confused with seasickness, intoxication or heat exhaustion. If someone complains of irritated eyes, head-

ache, nausea, weakness or dizziness, or you suspect carbon monoxide poisoning, immediately move the person to fresh air, investigate the cause, and take corrective action. Seek medical attention if necessary.

All engines and fuel burning appliances produce CO as exhaust. Direct and prolonged exposure to CO will cause BRAIN DAMAGE or DEATH.

Other symptoms that may signal exposure to CO: dizziness, flushed face, ears ringing, headaches, tightness of chest or hyperventilation, drowsiness, fatigue or weakness, inattention or confusion, lack of normal coordination, nausea and unconsciousness. The victim's skin also may turn red. A slight buildup of CO in the human body over several hours causes headache, nausea and other symptoms similar to food poisoning, motion sickness or the flu. Anyone with these symptoms should immediately be moved to an area of fresh air. Have the victim breathe deeply and seek immediate medical attention. To learn more about CO poisoning, contact your local health authorities.

### **Carbon Monoxide Detector**

If the carbon monoxide detector is activated, this indicates the presence of CO, which can be fatal. Evacuate the cabin immediately. Make sure all passengers are accounted for. **DO NOT** enter the cabin until you know it is safe and the problem found and corrected.

CO detectors warn occupants of dangerous accumulation of CO gas. It is automatically activated whenever the house battery switch panel feed breaker is "ON." When powered, the green indicator will flash for ten to fifteen minutes, indicating the unit is in its warm-up stage. The green power indicator will stop flashing when the sensor has reached optimum operating temperature. The indicator will then switch from flashing green to solid green, indicating the detector is activate.

Make sure the battery switch is on and the power light is lit whenever the cabin is occupied.

This device uses a micro controller to continuously measure and accumulate CO levels. Should a very high level of CO exist, the alarm will sound within a few minutes. If small quantities are present or high levels are short-lived, the detector will accumulate the information and determine when an alarm level has been reached.

While a CO detector enhances your protection from CO poisoning, it does not guarantee it will not occur. Do not use CO detectors as a replacement for ordinary precautions or periodic inspections of equipment. Never rely on alarm systems to save lives; common sense is still the best form of protection. Remember, the boat operator carries the ultimate responsibility to make sure the boat is properly ventilated and passengers are not exposed to dangerous levels of CO. Be alert to the symptoms and early warning signs of carbon monoxide.

CO detectors are very reliable and rarely sound false alarms. If the alarm sounds, DO NOT think it is false. If anyone has been exposed to CO, move them into fresh air immediately. Never disable the CO detector because you think the alarm may be false.

## Carbon Monoxide Poisoning

Carbon monoxide (CO) is a by-product of combustion, is invisible, tasteless, odorless and is produced by all engines and most heating and cooking appliances. It exists wherever fuels are burned to generate power or heat. The most common sources of CO on boats are combustion engines, auxiliary generators and propane or butane stoves.

These produce large amounts of CO and should never be operated while sleeping. High concentrations of CO can be fatal within minutes. Many cases of CO poisoning indicate that while victims are aware they are not well, they become so disoriented they are unable to save themselves by either exiting the area or calling for help. Also, young children, elderly persons and pets may be the first affected. Drug or alcohol use increases the effect of CO exposure. Individuals with cardiac or respiratory conditions

are very susceptible to the dangers of CO. CO poisoning is especially dangerous during sleep while victims are unaware of any side effects.

Low levels of CO over an extended period of time can be just as lethal as high doses over a short period. Therefore, low levels of CO can cause the alarm to sound before persons notice any symptoms.

Contact the detector manufacturer, the Pursuit Customer Relations Department or your local fire department for assistance in finding and correcting the situation.

In certain situations, boats can have a problem due to the "station wagon effect" where engine exhaust fumes are captured in the vessel by the vacuum or low pressure area, usually the cockpit, bridge deck and cabin, that can be created by the forward speed of the boat. Boats that are underway should close all aft facing portholes, hatches and doors. The forward facing deck hatches should be open whenever possible to help pressurize living spaces of the boat. Sleeping, particularly in aft cabins, should not be permitted while underway. Proper ventilation must be maintained on the bridge deck by opening a forward window or windshield to drive fumes away from the occupants. The canvas drop or aft curtain must be removed and side curtains should be opened or removed to increase airflow and maintain proper ventilation whenever the engines are running.

DO NOT operate the engines with side curtains closed and the aft or drop curtain installed.

Use extreme caution while anchored or in a slip and an auxiliary power generator is operating. Calm wind nights can easily allow fumes to enter the boat. Inspect the exhaust systems of propulsion and the auxiliary generators, if equipped, frequently for possible leaks. High concentrations of CO in your boat can originate from an adjacent boat through open hatches or windows.

Failure to properly ventilate the boat while the engines are running can cause CO to

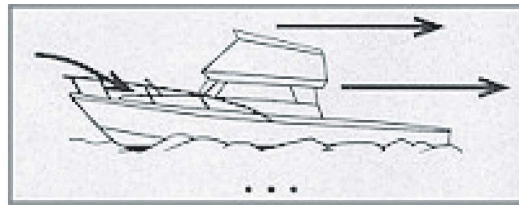

OPERATING SAFELY

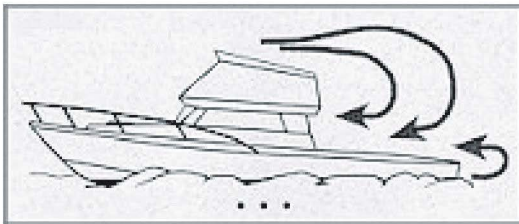

BACK DRAFTING / STATION WAGON EFFECT



NEARBY BOAT GENERATOR EXHAUST

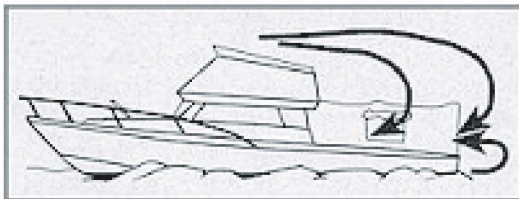

BACK DRAFTING / STATION WAGON EFFECT

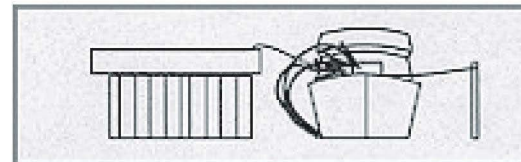

ONBOARD BOAT GENERATOR EXHAUST

accumulate within the cabin. Make sure to ventilate the boat and to avoid CO from accumulating in the boat whenever an engine is running.

Read the book entitled, "Sportfish, Cruisers, Yachts - Owner's Manual" and the owner's manual supplied by the CO detector manufacturer for additional information regarding the hazards and symptoms of CO gas, CO poisoning and operation instructions. If you did not receive these manuals, contact the Pursuit Customer Relations Department.

Many manufacturers of carbon monoxide detectors offer a testing and recertification program. We recommend that you contact the manufacturer of your CO detector and have it tested and recertified periodically. Certain electronic equipment have a limited life span, follow the CO detectors manufacturers recommendations on when the detector must be replaced.

## 9.6 First Aid

It is the boat operator's responsibility to be familiar with proper first-aid procedures and be able to care for minor injuries or illnesses of your passengers. In an emergency, you could be far from professional medical assistance, so be prepared. We recommend you be prepared by receiving training in basic first aid and CPR, through classes given by the Red Cross or your local hospital.



Equip your boat with at least a simple marine first-aid kit and a first-aid manual. The marine first-aid kit should be designed for the marine environment and be well supplied. Keep it accessible so each person onboard knows where it is located. As supplies are used, replace them. Some common drugs and antiseptics can lose their strength or become unstable as they age. Ask a medical professional about the supplies you should carry and the safe shelf life of prescription drugs or other medical supplies you carry. Replace old supplies whether they have been used or not.

In many emergency situations, the Coast Guard can provide assistance in obtaining medical advice for treatment of serious injuries or illness. If you are within VHF range of a Coast Guard Station, make the initial contact on channel 16 and follow their instructions.

## 9.7 Required Safety Equipment

In addition to items installed by Pursuit, certain other equipment is required by the U.S. Coast Guard to help ensure passenger safety. Items like a sea anchor, working anchor, extra dock lines, flare pistol, life vests, a line permanently secured to your ring buoy, etc., could at some time save your passengers' lives, or save your boat from damage. Refer to the "Federal Requirements and Safety Tips for Recreational Boats" pamphlet for a more detailed description of the required equipment. You can also contact the U.S. Coast Guard Boating Safety Hot line, 800-368-5647, for information on boat safety courses and brochures listing the Federal equipment requirements. Also, check your local and state regulations.

The Coast Guard Auxiliary offers a "Courtesy Examination." This inspection will help ensure your boat is equipped with all of the necessary safety equipment.

The following is a list of the accessory equipment required on your boat by the U.S. Coast Guard:

## Personal Flotation Devices (PFD's)

PFD's must be Coast Guard approved, in good and serviceable condition, and of appropriate size for the intended user. Wearable PFD's must be readily accessible, meaning you must be able to put them on in a reasonable amount of time in an emergency. Though not required, the Coast Guard emphasizes that PFD's should be worn at all times when the vessel is underway. Throwable devices must be immediately available for use. All Pursuit boats must be equipped with at least one Type I, II or III PFD for each person onboard, plus one throwable device (Type IV).

## Visual Distress Signals

All Pursuit boats used on coastal waters, the Great Lakes, territorial seas, and those waters connected directly to them, must be equipped with Coast Guard approved visual distress signals. These signals are either Pyrotechnic or Non-Pyrotechnic devices.

## Pyrotechnic Visual Distress Signals

Pyrotechnic visual distress signals must be Coast Guard approved, in serviceable condition and readily accessible. They are marked with a date showing the service life, which must not have expired. A minimum of three are required. Some pyrotechnic signals meet both day and night use requirements. They should be stored in a cool, dry location. They include;

- pyrotechnic red flares, hand held or aerial.
- pyrotechnic orange smoke, hand-held or floating.
- launchers for aerial red meteors or parachute flares.

Pyrotechnics are universally recognized as excellent distress signals. However, there is potential for injury and property damage if not handled properly. These devices produce a very hot flame and the residue can cause burns and ignite flammable material. Pistol launched and hand-held parachute flares and meteors have many characteris-

tics of a firearm and must be handled with caution. In some states they are considered a firearm and prohibited from use. Make sure you are careful and follow the manufacturer's instructions when using pyrotechnic distress signals.

### **WARNING**

**FIRE/EXPLOSION HAZARD**  
**Pyrotechnic signaling devices can cause fire and/or explosion, death, serious injury and property damage if misused. Follow the manufacturer's directions in the use of these signaling devices.**

### Non-Pyrotechnic Devices

Non-Pyrotechnic visual distress signals must be in serviceable condition, readily accessible, and certified by the manufacturer as complying with U.S. Coast Guard requirements. They include:

#### Orange Distress Flag, day use only.

The distress flag is a day signal only. It must be at least 3 x 3 feet with a black square and ball on an orange background. It is most distinctive when attached and waved from a paddle or boat hook.

#### Electric Distress Light, night use only.

The electric distress light is accepted for night use only and must automatically flash the international SOS distress signal. Under Inland Navigation Rules, a high intensity white light flashing at regular intervals from 50-70 times per minute is considered a distress signal.

### Sound Signaling Devices

The navigation rules require sound signals to be made under certain circumstances. Recreational vessels are also required to sound fog signals during periods of reduced visibility. Therefore, you must have some means of making an efficient sound signal.

### Navigation Lights

Recreational boats are required to display navigation lights between sunset and sunrise and other periods of reduced visibility (fog, rain, haze, etc.) Navigation lights are intended to keep other vessels informed of your presence and course. Your Pursuit boat is equipped with the navigation lights required by the U.S. Coast Guard at the time of manufacture. It is up to you to make sure they are visible, operational and turned on when required.

The navigation lights on your Pursuit comply with the Coast Guard 72 COLREGS standard that is in place.

Periodically test and verify that the bow fixture containing the red (port) and green (starboard) and masthead white all-around light and mast white stern light illuminate when the navigation lights are turned ON. Replace any burned out bulbs or light fixtures that are not working.

Modifying the navigation light system with the addition of additional lights, or removing lights, could cause the system to be incompliant with the Coast Guard 72 COLREGS standard. Additional lights could diminish the visibility of the installed navigation lights or be confused with navigation lights.

Modifying or replacing the navigation light fixtures with something that is not an exact replacement could cause the system to be incompliant with the Coast Guard 72 COLREGS standard. The fixtures used on your Pursuit meet the 72 COLREGS standard for the length of your boat and visibility required. Consult your Pursuit dealer when considering an addition to, removal of, or change to a navigation light fixture.

The operator is responsible for making sure the navigation lights are in good working order and are not obstructed. Navigation lights should not be modified, and additional lights should not be added if they could diminish the visibility of navigation lights or be confused with navigation lights.

The installed navigation lights may have a date indicating when the lighting quality may diminish. Replace the navigation lights before the indicated expiration date to maintain compliance and safety.

## Fire Extinguishers

Pursuit Boats provides locations for two fire extinguishers on boats under 26 feet. Boats over 26 feet have provisions for up to three fire extinguishers. Boats equipped with cabins have one fire extinguisher located in the cabin, cockpit and helm areas. Center console boats have fire extinguishers mounted in the vicinity of the helm and passenger cockpit. Coast Guard approved fire extinguishers are hand-portable, either B-I or B-II classification and have a specific marine type mounting bracket. It is recommended the extinguishers be mounted in a readily accessible position.

### Fire extinguishers require regular inspections to ensure:

- seals and tamper indicators are not broken or missing.
- pressure gauges or indicators read in the operable range.
- no obvious physical damage, corrosion, leakage or clogged nozzles.

For information on the type and size fire extinguisher required for your boat, refer to the "Federal Requirements and Safety Tips for Recreational Boats" pamphlet or contact the U.S. Coast Guard Boating Safety Hot line, 1-800-368-5647.

For instructions on the proper maintenance and use of your fire extinguisher, refer to the information provided by the fire extinguisher manufacturer.

Information for halon or agent FE-241 extinguishers is provided by the manufacturer. It is extremely important that you read, understand and know how this system works; refer to the manufacturer's literature.

## Bilge And Fuel Fires

Fuel compartment and bilge fires or explosions are dangerous because of the presence of fuel. You must make the decision to fight the fire or abandon the boat. If the fire cannot be extinguished quickly or it is too intense to fight, abandoning the boat may be your only option. You must consider your safety, the safety of your passengers, the intensity of the fire and the possibility of an explosion in your decision.

If you find yourself in this situation, make sure all passengers have a life preserver on and go over the side and swim well upwind of the boat, to keep clear of any burning fuel that could be released and spread on the water as the boat burns or in the event of an explosion. When clear of the danger, check and account for all passengers who were onboard. Give whatever assistance you can to anyone in need or in the water without a buoyant device. Keep everyone together for morale and to aid rescue operations.

### **WARNING**

#### **BURN HAZARD**

**Fuel floating on water which is ignited can cause death or serious injury. Fuel will float on top of water and can burn. If the boat is abandoned, swim upwind, far enough to avoid fuel that can spread over the surface of the water.**

### 9.8 Additional Safety Equipment

Besides meeting the legal requirements, prudent boaters carry additional safety equipment. This is particularly important if you operate your boat offshore. You should consider the following items, depending on how you use your boat.

#### Satellite EPIRB 'S

EPIRB's (Emergency Position Indicating Radio Beacon) operate as part of a world wide distress system. When activated, EPIRB's will send distress code homing beacons that allow Coast Guard aircraft to identify and find them quickly. The satellites that receive and relay EPIRB signals are operated by the National Oceanic and Atmospheric Administration (NOAA) in the United States. The EPIRB should be mounted and registered according to the instructions provided with the beacon, so the beacon's unique distress code can be used to quickly identify the boat and owner.

#### Additional Equipment to Consider:

- VHF Radio
- Life Raft
- Spare Anchor
- Spare Keys
- Heaving Line
- Fenders
- First Aid Kit
- Portable Radio
- Flashlight and Batteries
- Mirror
- Searchlight
- Sunburn Lotion
- Tool Kit
- Ring Buoy
- Whistle or Horn
- Anchor
- Chart and Compass
- Boat Hook
- Spare Propellers
- Mooring Lines
- Food and Water
- Binoculars
- Sunglasses
- Marine Hardware
- Extra Clothing
- Spare Parts

## Operation

### 10.1 General

Before you start, become familiar with the various component systems and their operation, and perform a "Pre-Cruise System Check." A thorough understanding of the component systems and their operation is essential to operate the boat safely. This manual and the associated manufacturers' information have been provided to enhance your knowledge of your boat. Read them carefully, and also, read the book titled "Sportfish, Cruisers, Yachts - Owner's Manual."

Your boat must have the necessary safety equipment onboard and be in compliance with the U.S. Coast Guard, local and state safety regulations. There should be one Personal Floatation Device (PFD) for each person. Non-swimmers and small children should wear PFD's at all times. You should know and understand the "Rules of the Road" and have had an experienced operator brief you on the general operation of your new boat. At least one other person should be instructed on the proper operation of the boat in case the operator is suddenly incapacitated.

The operator is responsible for his safety and the safety of his passengers. When boarding or loading the boat, always step onto the boat, never jump.

 **WARNING**

**DROWNING OR LOSS OF CONTROL HAZARD**

**Ejection or sudden loss of control can cause death or serious injury from improper use of seating. DO NOT stand while driving above engine idle speeds and make sure cockpit seat is locked/secured and all passengers are seated when boat is underway.**

DO NOT allow passengers to sit on the seat backs, gunwales, bows, transoms or on fishing seats whenever the boat is underway.

Passengers should be seated to properly balance the load and must not obstruct the operator's view, particularly to the front.

Overloading and improper distribution of weight can cause the boat to become unstable and are significant causes of accidents. Know the weight capacity and horsepower rating of your boat. Do not overload or overpower your boat.

 **WARNING**

**OVERLOAD HAZARD**

**Overloading the boat beyond maximum load or altering the stability, buoyancy or center-of-gravity can result in death or serious injury. DO NOT exceed the maximum load or alter the center-of-gravity of the boat.**

Remember, it is the operator's responsibility to use good common sense and sound judgment in loading and operating the boat.

 **WARNING**

**SLIPPERY SURFACE HAZARD**

**Wet surfaces can generate slippery conditions which can result in death or serious injury. Use caution on wet surfaces.**

### 10.2 Homeland Security Restrictions

- Recreational boaters have a role in keeping our waterways safe and secure. Violators of the restrictions below can expect a quick and severe response:
- Do not approach within 100 yards, and slow to minimum speed within 500 yards of any U.S. Naval vessel. If you need to pass within 100 yards of a U.S. Naval vessel, for safe passage you must contact the U.S. Naval vessel or the Coast Guard escort vessel on VHF-FM channel 16.
- Observe and avoid all security zones. Avoid commercial port areas, especially those that involve military, cruise-line or



petroleum facilities. Observe and avoid other restricted areas near dams, power plants, etc.

- Do not stop or anchor beneath bridges or in channels.

## America's Waterway Watch

America's Waterway Watch, a combined effort of the Coast Guard and its Reserve and Auxiliary, wants your help in keeping America's waterways safe and secure. America's Waterway Watch urges you to adopt a heightened sense of sensitivity toward unusual events or individuals you may encounter in or around ports, docks, marinas, riversides, beaches or waterfront communities. To report suspicious activities, call the National Response Center at 1-877-24WATCH or 1-800-424-8802. If there is immediate danger to life or property call 911 or call the Coast Guard on Marine channel 16.

## 10.3 Rules of the Road

As in driving an automobile, there are a few rules you must know for safe boating operation. The following information describes the basic navigation rules and action to be taken by vessels in a crossing, meeting or overtaking situation while operating in inland waters. These are basic examples and not intended to teach all the rules of navigation. For further information consult the "Navigation Rules" or contact the Coast Guard, Coast Guard Auxiliary, Department of Natural Resources, or your local boat club. These organizations sponsor courses in boat handling, including sponsor rules of the road. We strongly recommend such courses. Books on this subject are also available from your local library.

When two motor boats are crossing, the boat on the right has the right of way and should maintain its course and speed. The other vessel should slow down and permit it to pass. Both boats should sound appropriate signals.

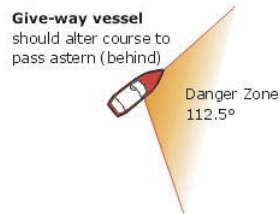

### CAUTION

**Avoid collisions by following navigation rules. If a collision appears unavoidable, both vessels must act. Prudence takes precedence over right-of-way rules if a crash is imminent. Less maneuverable boats generally have the right of way. Steer clear of the right-of-way boat and pass to its stern.**

When two motor boats are crossing, the boat on the right has the right of way and should maintain its course and speed. The other vessel should slow down and permit it to pass. Both boats should sound appropriate signals.

### Crossing situations

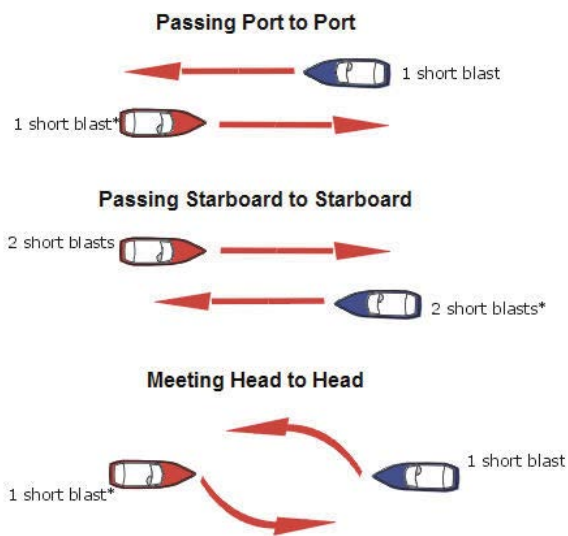

\* Response not sounded on International Waters

## Meeting Head-On Or Nearly-So Situations

When two motorboats are approaching each other head-on or nearly head-on, neither boat has the right of way. Both boats should reduce their speed and turn to the right, passing port side to port side and provide enough clearance for safe passage. Both boats should sound appropriate signals.

## Overtaking Situations

When one motorboat is overtaking another motorboat, the boat being passed has the right of way. The overtaking boat must make adjustments necessary to provide clearance for a safe passage of the other vessel and should sound appropriate signals.

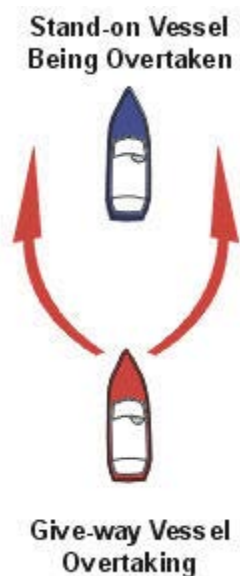

## The General Prudential Rule

In obeying the Rules of the Road, due regard must be given to all dangers of navigation and collision and to any special circumstances, including the limitations of the vessels, which may justify a departure from the rules that is necessary to avoid immediate danger or a collision.

## Navigation Aids

Aids to navigation are placed along coasts and navigable waters as guides to mark safe water and to assist mariners in determining their position in relation to land and hidden dangers. Each aid to navigation is used to provide specific information. Become familiar with these and any other markers used in your boating area.

Port Side Lateral System As seen entering from seaward (Green Light Only Odd Numbered Aids)		Starboard Lateral System As seen entering from seaward (Red Light Only Even Numbered Aids)	
	<b>Green Light</b> Chart Symbol "1" Fl G 6s		<b>Red Light</b> Chart Symbol "2" Fl R 6s
	<b>Green Lighted Buoy</b> Chart Symbol G "9" Fl G 4s		<b>Red Lighted Buoy</b> Chart Symbol R "8" Fl R 4s
	<b>Can</b> Chart Symbol G C "7"		<b>Nun</b> Chart Symbol R N "6"
	<b>Daymark</b> Chart Symbol G "1"		<b>Daymark</b> Chart Symbol R "2"

**CAUTION**

**Storms and waves can move buoys, do not rely on buoys alone to determine your position.**

## 10.4 Pre-Cruise Check

### Before Starting The Engines:

- Check the weather forecast. Decide if your planned cruise can be made safely.
- Make sure all required documents are onboard.
- Make sure all necessary safety equipment is onboard and operative; items like running lights, spotlight, life saving devices, etc. Refer to Safety Equipment for additional information.

Each person onboard must have at least one personal flotation device onboard and one throwable device. Check the U.S. Coast Guard standards for the correct type required for your boat.

- Make sure signal kits are onboard and are in good operating condition and are not expired.
- Make sure you have sufficient water and other provisions for the planned cruise.
- Leave a written message listing details of your planned cruise (Float Plan) with a close friend ashore. Include a description of your boat, where you intend to cruise, schedule of your arrival in the cruising area and when you expect to return. Keep the person informed of any changes in your plan to prevent false alarms. This information can tell authorities where to look and your boat type in the event you fail to arrive.
- Check the amount of fuel onboard. Observe the “rule of thirds”: one third of the fuel for the trip out, one third to return and one third in reserve. An additional 15% may be consumed in rough seas.
- Check the water separating fuel filters for water.
- Turn on the battery switches.
- Check for bilge water and for other signs of potential problems. Monitor for the scent of fuel fumes.
- Test the automatic and manual bilge pump switches to make sure the system is working properly.
- Have a tool kit and spare parts onboard.

**The kit should include basic tools:**

- Spark Plug Wrench
- Hammer
- Spark Plug Gap Gauge
- Electrician’s Tape
- Screwdrivers
- Lubricating Oil
- Pliers
- Jackknife
- Adjustable Wrench
- Vise Grip Pliers
- Needle Nose Pliers
- Wire Crimping Tool
- End Wrench Set
- Wire Connector Set

**The spare parts kit should include:**

- Extra Light Bulbs
  - Spark Plugs
  - Fuses and Circuit Breakers
  - Flashlight and Batteries
  - Drain Plugs
  - Engine Oil
  - Propellers
  - Fuel Filters
  - Propeller Nuts
  - Fuel Hose and Clamps
- Make sure all fire extinguishers are in position and in good operating condition.
  - Make sure the shift control is in NEUTRAL.
  - Make sure the emergency engine stop lanyard is attached to the operator and the stop switch.

### 10.5 Operating your Boat

The operator must be seated, and ready with the controls (steering/throttle) when the engine is started or running.

**After Starting the Engines:**

- Check engine gauges. Make sure all are reading normally.
- Visibly check engines to be sure there are no apparent water, fuel or oil leaks.
- Check operation of engine cooling systems.
- Check controls and steering for smooth and proper operation.
- Allow engines to warm up for 10 to 15 minutes before operating them above idle speeds.
- Make sure all lines, cables, anchors, etc. for securing the boat are onboard and in good condition. All lines should be coiled, secured and off the decks when underway.
- Have a safe cruise and enjoy yourself.

**REMEMBER:**

When operating a boat, you accept the responsibility for the boat, safety of passengers and others out enjoying the water.

- Alcohol and any mind altering chemicals can severely reduce your reaction time and affect your better judgment.
- Alcohol reduces the ability to react.
- Alcohol makes it difficult to judge speed and distance or track moving objects.
- Alcohol reduces night vision and ability to distinguish red from green.

**STAY ALERT.** The use of alcohol or any other mind altering chemicals that impair judgment, pose a serious threat to you and others. The boat operator is responsible for their consequences and behavior of passengers.

**⚠ WARNING**

**IMPAIRED OPERATION HAZARD**  
**Operating any boat while intoxicated or under the influence of other drugs can cause death or serious injury. DO NOT operate any boat under the influence of any mind-altering chemical.**

Avoid sea conditions that are beyond the skill and experience of you and your crew.

Make sure at least one other person onboard is instructed in the operation of the boat and it is operated in compliance with all state and local laws.

**DO NOT** operate the boat unless it is completely assembled. Make sure all fasteners are tight and adjustments are to specifications.

Before operating the boat for the first time, read the engine break-in procedures. Refer to the engine owner's manual. Since different types of engines are used, have your dealer describe the operating procedures for your boat. For more instructions on "How to Operate the Boat," read the instructions given to you for your engines.

For more instructions on safety, equipment and boat handling, enroll in one of the several free boating courses offered. For information on the courses offered in your area, call the "Boating Safety Hot line," 800-368-5647.

If the drive unit hits an underwater object, stop the engine. Inspect drive unit for damage. If damaged contact your dealer for a complete inspection and repair of the unit.

### Stopping the Boat

- Allow engines to drop to the idle speed.
- Shift controls to NEUTRAL.

If the engines have been run at high speed for a long period of time, allow engines to cool by running at idle for 3 to 5 minutes.

- Turn the ignition keys "OFF."
- Raise the trim tabs to full "UP" position.

**NOTICE**

**Turn off engines at idle speed. Racing the engine before switching it off can draw water into the engine through the exhaust, resulting in internal damage.**

### After operation:

- If operated in saltwater, wash the boat and all equipment with soap and water. Flush the engines using fresh water. Refer to the engine owner's manual for instructions on flushing.
- Check the bilge area for debris and excess water.
- Fill the fuel tanks to near full to reduce condensation. Allow room in the tanks for the fuel to expand without being forced out the vent.
- Turn off all electrical equipment except the automatic bilge pumps.
- If you are going to leave the boat unattended for a long period of time, put the battery main switches to "OFF" and close all seacocks.
- Make sure the boat is securely moored.

 **CAUTION**

To prevent damage, close all sea-cocks before leaving the boat.

## 10.6 Fishing

Fishing can be very exciting and distracting for the operator of the boat when the action gets intense. Be conscious that your primary responsibility is operating the boat safely to protect yourself, your passengers and other boats around you. Make sure the helm is properly manned and is never left unattended while trolling.

If you are fishing in an area that is crowded with other fishing boats, it may be difficult to follow the rules of the road. This situation can become especially difficult when most boats are trolling. Be courteous and exercise good common sense. Avoid trying to assert your right of way and stay clear of preventing tangled or cut lines and other unpleasant encounters. Also, keep in mind that fishing line wrapped around a propeller shaft can cause damage to the lower unit seal.

## 10.7 Docking, Anchoring and Mooring

### Docking and Docklines

Maneuvering a boat near a dock and securing it requires skill and techniques that are unique to water and wind conditions, and the dock layout. If possible, position a crew member at the bow and stern to assist with the lines and docking. While maneuvering close to the dock, compensate for wind and current, and anticipate how you can use them to help docking. Practice in open water using an imaginary dock to develop a sense for how the boat handles in different scenarios. You must be able to understand docking techniques before problems occur.

Approaching a dock or backing into a slip in high winds or strong currents requires skill. If you are new to handling a boat, take lessons from an experienced pilot and learn to

maneuver in tight quarters in less than ideal conditions. Also, practice away from the dock during windy conditions.

Dock lines are generally twisted or braided nylon. Nylon is strong and stretches to absorb shock. Nylon also has a long life and is soft and easy on the hands. The size of the line, will vary with the size of the boat. Typically a 30 to 40 foot boat will use 5/8-inch line and a 20 to 30 foot boat will use 1/2-inch line. The number of lines and their configuration will vary depending on the dock, the range of the tide, and other factors. Usually a combination of bow, stern and spring lines is used to secure the boat.

### Maneuvering to the Dock

Approach the dock slowly at a 30 to 40 degree angle. When possible, approach against the wind or current. Turn the engines straight and shift to neutral when you feel you have enough momentum to reach the dock. Use reverse to slow the boat and pull the stern toward the dock as the boat approaches. If you approached properly, the boat will lightly touch the pilings at the same time forward momentum is stopped. Have the dock lines ready and secure the boat as soon as it stops. Use fenders to protect the boat while it is docked. Keep the engines running until the lines are secured.

### Backing into a Slip

Approach the slip with the stern against the wind or current and the engines straight ahead. Use the engines and turn the steering wheel to maneuver the boat into alignment with the slip. Reverse the engines and slowly back into the slip. Shift from reverse to neutral frequently at idle to prevent the boat from gaining too much speed. Move the stern right and left by shifting the engines in and out of gear or turning the wheel. When nearly in the slip all the way, straighten the engines and shift to forward to stop. Keep the engines running until the lines are secured.

## Securing Docklines

Securing a boat along side the dock typically requires a bow and stern line and two spring lines. The bow and stern lines are usually secured to the dock at a 40 degree angle aft of the stern cleat and forward of the bow cleat. The after bow spring line is secured to the dock at a 40 degree angle aft of the after bow spring cleat. The forward quarter spring is secured to the dock at a 40 degree angle forward of the stern cleat. The spring lines keep the boat square to the dock and reduce fore and aft movement while allowing the boat to move up and down with the tide.

Securing a boat in a slip is somewhat different. It typically requires two bow lines secured to pilings on each side of the bow, two stern lines secured to the dock and two spring lines that prevent the boat from hitting the dock. The bow lines are typically secured with enough slack to allow the boat to ride the tide. The stern lines are crossed. One line runs from the port aft boat cleat to the starboard dock cleat and the other line runs from the starboard aft boat cleat to the port cleat on the dock. The stern lines center the boat, control the forward motion and allow the boat to ride the tide. Two forward quarter spring lines typically are secured to the stern cleats and to mid ship pilings or cleats. The spring lines keep the boat from backing into the dock while allowing it to ride the tide.

## Leaving the Dock

Start the engines and let them warm up for 10 to 15 minutes before releasing the lines. Boats steer from the stern and it is important you achieve enough clearance at the stern to maneuver the boat as quickly as possible. Push the stern off and maneuver to gain stern clearance quickly. Proceed slowly until the boat has cleared the dock and other boats.

## Mooring

Approach the mooring buoy heading into the wind or current. Shift to neutral when you have just enough headway to reach the

buoy. Position a crew member on the bow to retrieve the buoy with a boat hook and secure the line. Keep the engines running, until the line is secure.

## Leaving a Mooring

Start the engines and let them warm up before releasing the mooring line. The boat will already be headed into the wind, so move it forward enough to loosen the line and untie it. Back the boat away until you can see the buoy and slowly move away.

## Anchoring

Make sure the bitter end of the anchor rode is attached to the boat before dropping the anchor. Bring the bow into the wind or current and put the engine in neutral. When the boat comes to a stop, lower the anchor over the bow. Allow enough rode so that it is at least 5 to 7 times the depth of the water and secure the line to a cleat. Use caution to avoid getting your feet or hands tangled in the line. Additional scope of 10 times the depth may be required for storm conditions. Check landmarks on shore to make sure the anchor is not dragging. If it is dragging, start over. It is prudent to use two anchors if you are anchoring overnight or in rough weather.

### **WARNING**

**SINKING OR DROWNING HAZARD**  
Anchoring at the stern can pull a boat under water. **DO NOT** anchor at the stern.

## Releasing the Anchor

Release the anchor by traversing to the point where the anchor line becomes vertical. It should release when you pass that point. If the anchor does not release, stop the boat directly above the anchor and tie the line to a cleat as tight as possible. The up and down movement of the boat will usually loosen the anchor. Make sure the anchor is secured and stowed before getting underway.

## 10.8 Controls, Steering or Propulsion System Failure

### WARNING

#### MOVING PARTS HAZARD

Contact with moving parts can entangle, cut and cause death or serious injury. DO NOT come close enough to make contact with any running machinery moving parts, i.e., engine or propeller. Contact can result in loss of body parts, strangulation, burns and/or severe loss of blood resulting in serious injury or death.

The engine covers are machinery guards and must be in place whenever the engines are running. DO NOT operate the boat without the covers in place unless you are performing a check or maintenance.

If the propulsion, control or steering system fails while you are operating the boat, bring both throttles to idle and shift to neutral. Determine if the boat should be anchored to prevent the boat from drifting or to hold the bow into the seas. Investigate and correct the problem if possible. Make sure the engines are off before investigating the problem. If you are unable to correct the problem, call for help.

## 10.9 Collision

If your boat is involved in a collision with another boat, dock, piling or a sandbar, your first priority is to check passengers for injuries and administer first aid if necessary. Once all passengers' situations are stabilized, thoroughly inspect the boat for damage. Check below decks for leaks and all control systems for proper operation. Plug all leaks or make the necessary repairs to the control systems before proceeding. Operate slowly and carefully, but take all necessary precautions to be safe. Request assistance if necessary. Haul the boat and make a thorough inspection of the hull, lower unit and control system for damage.

## 10.10 Grounding, Towing and Rendering Assistance

The law requires the owner or operator of a vessel to render assistance to any individual or vessel in distress, as long as his vessel is not endangered in the process.

If the boat should become disabled, or if another craft that is disabled requires assistance, be careful. The stress applied to a boat during towing can become excessive. Excessive stress can damage the structure and create a safety hazard for all onboard.

Freeing a grounded vessel, or towing a disabled boat requires specialized equipment and knowledge. Line failure and structural damage caused by improper towing have resulted in fatal injuries. To safely accomplish the towing task, we recommend this to be reserved for those with the right equipment and knowledge, e.g., the U.S. Coast Guard or a commercial towing company.

The mooring cleats or bow/stern eyes on Pursuit boats are not designed or intended to be used for towing or lifting. These cleats are designed as mooring cleats for securing the boat to a dock, pier, etc. only. DO NOT use these fittings for towing, lifting or attempting to free a grounded vessel.

When towing operations are underway, have everyone on both vessels stay clear of the tow line and surrounding area. DO NOT allow anyone to be in line with the tow rope; a dangerous, recoil can occur if the rope should break or pull free.

Running aground can cause serious injury to passengers and damage the boat and its underwater gear.

If your boat runs aground, evaluate the damage, then proceed at low speed to the nearest service facility and have an immediate inspection made before further use. A damaged boat can also take on water; keep all life saving devices close while heading to a dock area. If the boat cannot be immediately removed from the water, thoroughly inspect the bilge area for leaks.

## 10.11 Flooding or Capsizing

Boats can become unstable if they become flooded or completely swamped. Always be aware of the position of the boat to the seas and the amount of water in the bilge. Water entering the boat over the transom can usually be corrected by turning the boat into the waves. If the bilge is flooding because of a hole in the hull, the engine bracket or a defective hose, you may be able to plug it with rags, close the thru-hull valve or assist the pumps by bailing with buckets. Put a mayday call into the Coast Guard or nearby boats and distribute life jackets as soon as you discover your boat is in trouble.

If the boat becomes swamped and capsizes, you and your passengers should stay with the boat as long as you can. It is much easier for the Coast Guard, aircraft, or other boats to spot, than people in the water.

## 10.12 Transporting your Boat

Your Pursuit boat is a large boat and should only be trailered by professionals with the right equipment and knowledge to transport large boats without causing damage. Contact your dealer or the Pursuit Customer Relations Department if you are planning to transport your boat and have any questions in regard to the proper equipment and support for the hull.

Damaged from trailers can occur if the boat hull is not supported properly. Make sure the trailer bunks and pads are adjusted so they provide enough support for the hull and are not putting excessive pressure on the lifting strakes. Hull damage resulting from improper trailer support is not covered by the Pursuit warranty.

## 10.13 Trailering your Boat

The boat trailer is an important part of your boating package. The trailer must be matched to the weight of the boat. A trailer with a capacity too low will be unsafe on the road and cause abnormal wear. A trailer with a capacity too high, can damage the boat. Contact your dealer to evaluate your towing

vehicle and hitch, and to make sure you have the correct trailer for your boat.

### IMPORTANT

**Your Pursuit is heavy and the selection of your trailer is very important. We recommend using a bunk style trailer that incorporates a combination of heavy duty rollers to support the keel and long bunks running under and parallel to the stringers to support the hull. Trailers without bunks can cause damage and have a tendency to put extreme pressure points on the hull, especially on the lifting strakes. The situation worsens when launching or retrieving. Damage resulting from improper trailer support or the use a full roller trailer will not be covered by the Pursuit Warranty.**

If you trailer your boat, make sure your tow vehicle is capable of towing the weight of the trailer, boat and equipment and the weight of the passengers and equipment inside the vehicle. This may require the tow vehicle to be specially equipped with a larger engine, transmission, brakes and trailer tow package.

The following safety tips and a book titled "Sportfish, Cruisers, Yachts - Owner's Manual," provide additional information you should know before trailering your boat.

DO NOT use bow or stern eyes, cleats or any other hardware for the purpose of towing, being towed or lifting, they are not designed for that purpose.

Contact your dealer to evaluate your towing vehicle and hitch, and to make sure you have the correct trailer for your boat.

- Make sure the trailer is a match for the weight and hull design of the boat. More damage can occur by the stresses of road travel than by normal water operation. A boat hull is designed to be supported evenly by water. So, when it is transported on a trailer it should be sup-



ported as evenly across the hull as possible allowing for even distribution of the weight of the hull, engine and equipment.

- Make sure the trailer bunks and rollers properly support the hull and do not put pressure on the lifting strakes. The rollers and bunks must be kept in good condition to prevent scratching and gouging of the hull.
- The capacity rating of the trailer should be greater, but not to an extreme, than the combined weight of the boat, motor, and equipment. The gross vehicle weight rating must be shown on the trailer. Make sure the weight of the boat, engine, gear and trailer is not more than the gross vehicle weight rating.
- DO NOT use your boat and trailer as a means for hauling excess gear.
- Make sure the boat is securely fastened on the trailer to prevent movement between the boat and trailer. The bow rope, chain or turnbuckle in addition to the winch cable. Additional straps may be required across the beam of the boat. If these types of straps are used, protect your boat from chaffing or from the straps "slapping" the gelcoat. Cover area where straps are secured and twisting the straps before they are secured will help reduce the "slapping" affect. Your dealer can provide instructions on how to load, fasten and launch your boat.

### Before Going out on the Highway:

- **Canvas Enclosures** - must be removed when trailering. Canvas enclosures will be damaged, they are not designed to withstand the extreme wind pressure encountered while trailering. Remove and properly store enclosures before trailering.
- **Tow Ball And Trailer Coupler** - make sure they are the same size and bolts and nuts are tightly secured.

The coupler **MUST BE** completely over the ball and the latching mechanism **LOCKED DOWN**.

- **Load Trailer Evenly** - make sure load is evenly distributed from front to rear, as

well as side to side and has the correct distribution of weight on the hitch. Too much weight on the hitch will cause the rear of the tow vehicle to drag and may make steering more difficult. Too little weight on the hitch will cause the rig to fishtail and will make controlling the tow vehicle difficult. Contact your Pursuit dealer or the trailer manufacturer for the correct weight on the hitch for your trailer.

- **Safety Chains** - attach crisscrossing under the coupler to the frame of the tow vehicle. If the ball breaks, the trailer would follow in a straight line and prevent the coupler from dragging on the road. Make sure the trailer emergency brake cable or chain is also installed to the tow vehicle frame.
- **Lights** - make sure they are functioning properly.
- **Brakes** – check on a level parking area; roll forward and apply the brakes several times at increasing speeds to determine if the brakes on the tow vehicle and trailer are working properly.
- **Side View Mirrors** - make sure the tow vehicle mirrors are large enough to provide an unobstructed rear view on both sides of the vehicle.
- **Tires and Wheel Bearings** – check before getting on the road.

Make sure your tow vehicle and trailer are in compliance with all state and local laws for the area you will be trailering. Contact your state motor vehicle bureau for laws governing the towing of trailers.

### 10.14 Water Skiing

Your Pursuit can be equipped for water skiing. If you have never pulled skiers, you should observe, learn and practice from an experienced driver. If you are an experienced driver, become familiar with the boat and the way it handles before pulling a skier. The driver should also know the ability of the skiers and drive accordingly. The following safety precautions should be observed while towing water skiers.

- Water ski only in safe areas, away from other boats and swimmers, out of chan-

nels and in water free of underwater obstructions and water ski only during daylight hours.

- Make sure that anyone who skis can swim. DO NOT allow people who cannot swim to water ski.
- Make sure all skiers wear a proper life jacket. A water skier is considered onboard the boat and a Coast Guard approved life jacket is required. A skier should wear a flotation device designed to withstand the impact of hitting the water at high speed. A second person must be onboard to observe the skier so your attention can be directed to the safe operation of the boat.
- Approach a skier in the water from the downwind side and STOP THE ENGINE and forward motion of the boat before coming in close proximity to the skier.
- Give immediate attention to a fallen skier. A fallen skier is very hard to see by other boats and is extremely vulnerable. When a skier falls, be prepared to turn the boat immediately and return to the skier. Never leave a fallen skier alone in the water for any reason.

For additional information on water skiing, including hand signals and water skiing manuals, contact the American Water Skiing Association - 863-324-4341 or visit their Web Site at [www.usawaterski.org](http://www.usawaterski.org).

## DANGER

**CARBON MONOXIDE POISONING AND/OR ROTATING PARTS HAZARD**  
Poisonous CO gases are present at the rear of the boat when an engine is running. A rotating propeller can cut or entangle swimmers, both of these hazards will cause death or serious injury. DO NOT use the swim/boarding platform when the engine is running.

Remove and store the ladder properly before starting the engines.

## 10.15 Man Overboard

If someone falls overboard, be prepared to react quickly, especially when you are off-shore. The following procedures will help you in recovering a person that has fallen overboard.

- Immediately stop the boat and sound a man overboard alarm and have all passengers point to the person in the water.
- Circle around quickly and throw a throwable PFD, cushion or life jacket to the person and if possible, another to use as a marker.
- Keep the person on the driver side of the boat to keep them in sight.
- Approach the person from the downwind side and maneuver the boat so the propellers are well clear of the person in the water.
- Turn off the engines when person is alongside and use a ring buoy or a boat cushion with a line attached, a paddle or boathook to assist person to the boat; make sure you do not hit them with the ring buoy or the boat.
- Pull person to the boat and assist onboard.
- Check person for injuries and administer first aid if necessary, if the injuries are serious, call for help immediately.

Refer to Safety Equipment for more information on first aid and requesting emergency medical assistance.

## 10.16 Trash Disposal

The discharge of plastic trash or trash mixed with plastic is illegal anywhere in the marine environment. It is also illegal to discharge garbage in the navigable waters of the United States including the great lakes.

Regional, State, and local restrictions on garbage discharges also may apply. Vessels of 26 feet or longer must display in a prominent location, a durable placard at least 4 by 9 inches notifying the crew and passengers of the discharge restrictions.

Responsible boaters store refuse in bags and disposed of it properly on shore. Make sure your passengers are aware of the local waste laws and the trash management procedure on your boat.

## Routine Maintenance

### 11.1 General

#### **WARNING**

##### **FIRE/EXPLOSION/ASPHYXIATION HAZARD**

Cleaning agents and paint ingredients can be flammable and/or explosive, or dangerous to inhale. Make sure ventilation is adequate, wear proper personal protection and dispose of rags properly ashore.

Vapors from flammable solvents can cause fire, explosion or asphyxiation resulting in death or serious injury. Keep open flame or spark away from work area. **DO NOT** paint unless in a well-ventilated area.

Before using a cleaning product, refer to the product directions and specifications.

If urethane foam is used in the construction of your boat, be careful with high temperatures or flames in these areas. Urethane foam can ignite. **DO NOT** smoke, weld or burn. Avoid the use of space heaters and lights in areas where urethane foam is present. If ignited, urethane foam burns rapidly, produces extreme heat, releases hazardous gases and consumes much oxygen.

### 11.2 Exterior Hull and Deck

#### Hull Cleaning - Below the Waterline

When the boat is removed from the water, clean the outer bottom surface immediately. Algae, grass, dirt and other marine growth can be removed easier while the hull is still wet. Use a pressure cleaner or a hard bristle brush to clean the surface.

#### Bottom Painting

If the boat is to be left in the water for more than sixty (60) days in any ninety (90) day period an epoxy barrier coat should be

applied to prevent blistering or osmosis prior to applying antifouling paint. Because of variations in water temperature, marine growth and pollution in different regions, your dealer and/or a qualified boat yard in your area should be consulted when deciding what bottom paint system to apply to your hull, because pollution and marine growth can damage fiberglass hulls.

Sanding or sandblasting the hull bottom will damage the fiberglass. Only use standard antifouling paints and fiberglass wax removers and primers recommended by the antifouling paint manufacturer when preparing the hull for bottom paint. Sanding or sandblasting and the use of a coating other than standard antifouling paint or epoxy barrier coatings are not recommended and will void the hull blister warranty.

**DO NOT** allow antifouling paint to contact the outboard engine. Most antifouling paints contain copper which will cause severe galvanic damage to the motor. Leave a 1/2" (12.7 mm) barrier between the hull bottom paint and outboard engine.

Most bottom paints require maintenance, especially when the boat is in saltwater or not used for extended periods, or after dry storage. If the hull bottom has been painted with antifouling paint, contact your dealer for the recommended maintenance procedures.

#### Sacrificial Anodes

Sacrificial zinc anodes are installed on the trim tabs, transom and outboard engines. The transom anode is connected to the bonding system and protects the underwater hardware that is bonded.

The anodes are less noble than copper based alloys and aluminum and will deteriorate first, protecting the more noble underwater hardware against galvanic corrosion. Anodes should be checked monthly and changed when they are 75% of their original size. When replacing the anodes, make sure the contact surfaces are clean, shiny metal and free of paint and corrosion. Never paint over the anode or protect it.

Boats stored in the water will require anodes to be replaced at least every 6 months to one year. Anodes requiring replacement more frequently may indicate a stray current problem within the boat or at the slip or marina. Anodes that do not need to be replaced after one year may not be providing the proper protection. Loose or low quality anodes could be the problem. Contact your dealer for the proper size and type of anodes to be used and the specific installation procedure.

### Fiberglass Gelcoat Surfaces

Normal maintenance requires only washing with mild soap and water. A stiff brush can be used on the nonskid areas. Kerosene or commercially prepared products will remove oil and tar which could be a problem on trailered boats. DO NOT use harsh abrasive and chemical cleaners because they can damage or dull the gelcoat, reducing its life and making it more susceptible to stains. When the boat is used in saltwater, wash it thoroughly with soap and water after each use.

Sudden changes in temperature can affect gelcoat. When planning on moving your boat from outdoors to a heated location, allow the change of temperature to be gradual. Warm the location slowly after the boat is brought inside to allow the boat to change temperature slowly as the location is warmed. Or, if you are moving your boat from a warmer area to a colder one, wait for the temperature to be closer to the temperature of the warmer area or allow the warmer area and the boat to cool down.

At least once a season, wash and wax all exposed fiberglass surfaces. Use a high quality automotive or boat wax. Follow the procedure recommended by the wax manufacturer. Washing and waxing of your boat will have the same beneficial effects as they have on an automobile finish. The wax will fill minute scratches and pores which help prevent soiling and will extend the life of the gelcoat.

After the boat is exposed to the direct sunlight for a period of time, the color in the gel-

coat tends to fade, dull or chalk from oxidation of the gel. This condition will be more apparent with dark colors, which require more frequent maintenance. A heavier buffing is required to bring the gelcoat back to its original luster. For power cleaning use a light cleaner. To clean the boat by hand, use a heavier automotive cleaner. Before cleaning the surfaces, read the instructions given with the cleaner. After cleaning the surfaces, apply wax and polish all fiberglass surfaces except the nonskid areas.

If the fiberglass should become damaged and need repair, contact your dealer for an authorized repair person to make the repairs.

### WARNING

**SLIPPERY SURFACE HAZARD**  
Cleaning surfaces can generate slippery conditions which can result in death or serious injury. Use caution when cleaning with detergents. Rinse thoroughly.

Be careful when walking on wet gelcoat surfaces.

DO NOT wax nonskid surfaces, these could make them slippery and increase the possibility of injury.

### Stainless Steel Hardware

When using the boat in saltwater, wash hardware with soap and water after each use. When your boat is used in a higher corrosive environment, such as saltwater, water with a higher sulfur content or polluted water, stainless steel will periodically develop surface rust stains; this is normal under these conditions.

Clean and protect by using a high quality boat or automotive wax or a commercial metal cleaner and protector.

DO NOT use citrus-based, abrasive materials such as sandpaper, bronze wool, or steel

wool on stainless steel as damage will result.

## Anodized Aluminum Surfaces

Wash periodically with soap and water to keep it clean. If the boat is used in saltwater or polluted water, wash with soap and water after each use. Saltwater allowed to remain on anodized aluminum will penetrate the anodized coating and attack the aluminum.

Hardtops with aluminum frames, bimini tops and towers with canvas and/or fiberglass tops require special attention to the anodized aluminum just below the top. This area is subject to salt build-up from salty condensation and sea spray. It is often overlooked when the boat is washed and will not be rinsed by the rain. The aluminum just below the top is more likely to become pitted than the exposed aluminum on the structure. Make sure these areas are washed frequently with soap and water and rinsed thoroughly. Pay particular attention to places where the top material and lacing contact the frame. Coat the entire frame with a metal protector made for anodized aluminum once a month to protect against pitting and corrosion caused by the harsh effects of saltwater. The anodized aluminum used on your Pursuit was coated with a metal protector called Aluma Guard at the factory. Aluma Guard is a nonabrasive marine metal protector that protects anodized aluminum, stainless steel, brass and chrome. It also protects color anodizing from fading and discoloring due to harmful ultraviolet rays. Aluma Guard is available from your dealer or Rupp Marine Inc., 4761 Anchor Avenue, P.O. Drawer F, Port Salerno, FL 34992.

Aluma Guard and other metal protectors can make the metal slippery and should not be used on tower ladders, steering wheels and other areas for gripping or stepping.

Stains can be removed with a metal polish or fine polishing compound. To minimize corrosion, use a caulking compound to bed hardware and fasteners mounted to aluminum fabrications. If the anodized coating is badly scratched it can be touched up with paint.

With proper care, anodized aluminum will provide many years of service.

Contact Pursuit Customer Relations before making any modifications to aluminum fabrications. Unauthorized modifications can void the warranty.

## Powder Coated (Painted) Aluminum Surfaces

Regular care is necessary to maintain the appearance of the powder coat finish. Build-up of salt and grime can hold moisture and damage powder coatings. This buildup can cause a corrosive condition that can damage the coating, especially in a salt air or coastal environment.

- Wash the finish regularly with warm water containing a pH neutral detergent (i.e. mild dish soap).
- Use a non-abrasive fiber cloth.
- Rinse thoroughly after cleaning.

## Chrome Hardware

Rinse with fresh water and wipe dry with towel or chamois after each use. Use a good chrome cleaner and polish on all chrome hardware. Clean and wax chrome prior to extended storage. In saltwater or other harsh environments, clean and wax more often.

## Acrylic Plastic

Acrylic plastic scratches easily. DO NOT use a dry cloth or glass cleaning solutions on acrylic. Use a soft cloth and mild soap and water for routine cleaning. Solvents and products containing ammonia can permanently damage acrylic plastic.

Fine scratches can be removed with a fine automotive clear coat polishing compound. A coat of automotive or boat wax is beneficial to protect the surface.

DO NOT use the following on acrylic plastic:

- Abrasive cleaners
- Acetone
- Solvents
- Alcohol
- Glass cleaners
- Cleaners containing ammonia

### Engines

Proper engine maintenance is essential to performance and reliability of your outboard engines. Maintenance schedules and procedures are outlined in your engine owner's manual, follow them exactly.

Flush the system when the boat is out of the water. If the boat is used in saltwater, flush daily.

The age of gasoline can affect engine performance. Chemical changes occur as the gasoline ages, causing deposits and varnish in the fuel system and reduces the octane rating of the fuel. Degraded fuel can damage the engine and boat fuel tank and lines. If your boat does not require at least one full tank of fresh fuel a month, add a fuel stabilizer to the gasoline to protect the fuel from degradation. Use only a fuel stabilizer recommended by your dealer or the engine manufacturer. Operate the boat at least 15 minutes after adding the stabilizer to allow the treated fuel to reach the engine. Your dealer or engine manufacturer can provide additional information on fuel degradation. For more recommendations for your specific area, check with your local Pursuit dealer.

Avoid using fuels with alcohol additives. Gasoline, extended with an alcohol blend, will absorb moisture from the air which can reach such concentrations that "phase separation" can occur where the water and alcohol mixture becomes heavy enough to settle out of the gasoline to the bottom of the tank. Since the fuel pick-up tube is near the bottom of the tank, phase separation can cause the engine to run poorly or not at all. This condition is more severe with methyl alcohol and will worsen as the alcohol content increases. Water or a jelly like substance in the fuel filters is an indication of possible

phase separation from the use of alcohol blended fuels.

Contact your Pursuit dealer or engine manufacturer for additional information regarding fuels and additives.

### Corian® Surfaces

Corian® is resistant to heat, but you should always use a hot pad or a trivet with rubber feet to protect Corian®. Avoid exposing Corian® to strong chemicals, such as paint removers, oven cleaners, etc. If contact occurs, flush the surface with water immediately. Soapy water or ammonia-based cleaners will remove most dirt and stains from all types of finishes.

DO NOT use the Corian® counter top as a cutting board.

Minor damage, scratches, general or chemical stains, scorching or burns and minor impact marks can be repaired on-site with a light abrasive cleanser and a product such as a Scotch-Brite® pad. For heavier damage, light sanding may be necessary. Heavy damage should be repaired by a Corian® licensed professional.

### Tempered Glass Sink

#### For best results:

- DO NOT use strong/abrasive cleaner. Test your cleaning solution on an unnoticeable area first, before applying to the entire surface.
- Wipe surfaces clean, immediately after applying cleaner.
- DO NOT allow cleaner to sit or soak on the surface.
- DO NOT use an abrasive brush or scouring pad to clean surfaces as damage will occur. Use only a soft, dampened sponge and cloth.
- Rinse and wipe the fixtures to prevent soap build-up.

## 11.3 Seats, Upholstery, Canvas and Enclosures

### Seat Slides and Swivel Bases

Perform the following periodically:

- Inspect and tighten mounting screws between seat slides and seat bottom.
- Inspect and tighten the mounting screws attaching seat bases to boat.
- Keep a light film of grease on manual seat slides.
- Keep a light film of grease on manual seat adjusting mechanism.
- Clean electric seat slides. DO NOT use harsh chemicals or abrasives. Lubrication is not required.

### Vinyl Upholstery

The vinyl upholstery used on the exterior seats and bolsters and headliner in the cabin should be cleaned with soap and water periodically. Stains, spills or soiling should be cleaned up immediately to prevent the possibility of permanent staining. When cleaning, rub gently. DO NOT use products containing ammonia, powdered abrasive cleaners, steel wool, strong solvents, acetone and lacquer solvents or other harsh chemicals as they can permanently damage or shorten the life of vinyl. Never use steam heat, heat guns or hair dryers.

Stronger cleaners, detergents and solvents may be effective in stain removal, but can cause either immediate damage or slow deterioration. Lotions, sun tan oil, waxes and polishes, etc., contain oils and dyes that can cause stiffening and staining of vinyls.

- Dry soil, dust and dirt - remove with a soft cloth.
- Dried on dirt - wash with a soft cloth dampened with water.
- Variations in surface gloss - wipe with a water-dampened soft cloth and allow to air dry.
- Stubborn dirt - wash with a soft cloth, dampened with Ivory Flakes® and water. Rinse with clean water.

- Stubborn spots and stains - spray with either Fantastik Cleaner® or Tannery Car Care Cleaner® and rub with a soft cloth. Rinse with clean water.
- Liquid spills - wipe with a clean absorbent cloth immediately. Rinse with clean water.
- Food grease and oily stains - spray with either Fantastik Cleaner® or Tannery Car Care Cleaner®, wiping with a soft cloth immediately. Be careful not to extend the area of contamination beyond its original boundary. Rinse with clean water.

### Canvas and Side Curtains

Acrylic canvas should be cleaned periodically by using a mild soap and water. Scrub lightly and rinse thoroughly to remove the soap. Do not use detergents. The top or accessories should never be folded or stored wet.

After several years, the acrylic canvas may lose some of its ability to shed water. If this occurs, wash the fabric and treat it with a commercially available water proofing designed for this purpose. Some leakage at the seams is normal and unavoidable with acrylic enclosures.

Side curtains and clear connectors can be cleaned with mild soap and water. Do not allow them to become badly soiled. Dirt, oil, mildew, and cleaning agents containing ammonia will shorten the life of the vinyl that is used for clear curtains. After cleaning the curtains and allowing them to dry, apply a non-lemon furniture polish or an acrylic plastic and clear plastic protector to extend the life of the curtains.

Vinyl curtains should be stored either rolled or flat, without folds or creases. Folding the curtains will make permanent creases that could cause the vinyl to crack.

DO NOT use any polish containing lemon or lemon scents; lemon juice attacks vinyl and shorten its life.



Lubricate snaps periodically with petroleum jelly or silicone grease. Lubricate zippers with silicone spray or paraffin.

Remove the bimini top, side curtains, clear connector, back drop and aft curtain when trailering. Canvas enclosures are not designed to withstand the extreme wind pressure encountered while trailering and will be damaged. Always remove and store properly before trailering.

### 11.4 Cabin Interior

Clean cabin interior just like you would clean a home interior.

- Teak woodwork - use teak oil.
- Carpeting - use a vacuum cleaner.
- Vinyl headliner - clean as previously explained.

Air and sunlight are very good cleansers. Periodically, place cushions, sleeping bags, etc. on deck, under the sun and fresh air to dry and air out. If cushions or equipment get wet with saltwater, remove and use clean, fresh water to rinse off the salt crystals. Salt retains moisture and will cause damage. Dry thoroughly and reinstall.

If you leave the boat for a long period of time, put all cushions on their sides, open all interior cabin and locker doors, and hang a commercially available mildew protector in the cabin.

Read the label carefully on mildew protectors and remove the protector and allow the cabin to ventilate completely before using the cabin.

### 11.5 Bilge

To keep the bilge clean and fresh, use a commercial bilge cleaner regularly. Follow the directions carefully. All exposed pumps and metal components should be sprayed with a protector periodically to reduce the corrosive effects of the high humidity present in these areas.

#### **WARNING**

##### **FIRE/EXPLOSION OR ASPHYXIATION HAZARD!**

**Fumes from flammable solvents can cause fire, explosion or asphyxiation resulting in death or serious injury. DO NOT use flammable solvents to clean the bilge.**

## Seasonal Maintenance

### 12.1 Storage and Lay-up

#### Before Hauling:

- Pump out the head. Flush the holding tank using clean soap, water, deodorizer and pump out cleaning solution.
- Leave the fuel tank nearly full to reduce condensation that can accumulate in the tank. Allow enough room for fuel to expand without leaking from the vents. Algae can grow in the accumulated water in diesel fuel tanks, especially in warm climates. Adding a high quality diesel fuel additive containing an algaecide may be required to control algae during storage in your area.
- Drain fresh water system.
- Refer to the engine owner's manual for detailed information on preparing the engines for storage.

#### Lifting

It is essential that care be used when lifting your boat. Make sure the spreader bar at each sling is at least as long as the distance across the widest point of the boat that the sling will surround. Put the slings in position. Refer to the drawing in the Schematics for the correct position of the lifting slings. The positions are marked with small labels on each side of the boat under the rubrails. Tie fore and aft slings together to prevent slings from sliding on the hull.

Elevating lifts are commonly used to store boats for extended periods. To provide proper support, the bunks that support the hull should be aligned with and run parallel to the hull stringers. The bow and stern eyes, if equipped should not be used as sole support for storage.

Your boat can be damaged from improper lifting and rough handling when being transported by lift trucks. Care and proper handling procedures must be used when using a lift truck to move your boat. DO NOT attempt to lift boat with a substantial amount of water in the bilge.

Severe gelcoat cracking or more serious hull damage can occur during hauling and launching if pressure is created on the gunwales (sheer) by the slings. Use flat, wide slings and spreaders long enough to keep pressure from the gunwales. DO NOT allow your boat to be hauled when the spreaders on the lift are not wide enough to take the pressure off the gunwales.

#### Supporting The Boat for Storage

A trailer, elevating lift or a well-made cradle is the best support for your boat during storage.

#### When storing the boat on a trailer for a long period:

- Make sure the rollers and pads support the hull of the boat and the trailer is on a level surface with the bow high enough so water will drain from the bilge and cockpit. The trailer must properly support the hull. The bunks and rollers should match the bottom of the hull and should not be putting pressure on the lifting strakes.
- Make sure the hitch is properly supported.
- Check the tires once each season. Add enough air for the correct amount of inflation for the tires.
- Make sure the engines are in the down position.

#### When storing the boat on a lift or cradle:

- The cradle must be specific for boat storage. Make sure lift or cradle is well supported with the bow high enough to provide proper drainage of the bilge. The cradle or lift must be in the proper fore and aft position to properly support the hull. When the cradle or lift is in the correct location, the bunks should match the bottom of hull and should not be putting pressure on the lifting strakes.
- Make sure the engines are in the down position.
- Make sure bunks and rollers are adjusted so they are not putting pressure on lifting strakes and are providing enough support for the hull. Hull damage

resulting from improper cradle or trailer support is not covered by the Pursuit warranty.

### Preparing The Boat For Storage:

- Remove the bilge drain plug(s), if installed.
- Thoroughly wash fiberglass exterior, especially the antifouling portion of the bottom. Remove as much marine growth as possible. Lightly wax the exterior fiberglass components.
- Remove all oxidation from the exterior hardware and apply a light film of moisture displacing lubricant.
- Remove propellers and grease the propeller shafts using light waterproof grease.
- Remove batteries and clean using clear, clean water. Make sure batteries have sufficient water and terminals are clean. Keep the batteries charged and stored in a cool, dry place and safe from freezing throughout the storage period.
- Refer to the Electrical System for information on the maintenance of the AC and DC electrical systems.
- Coat all faucets and exposed electrical components in the cabin and cockpit with a protecting oil.
- Clean, drain and completely dry the fish-boxes, sinks and livewells.
- Thoroughly clean the interior of the boat; vacuum all carpets and dry clean drapes and upholstery.
- Remove cushions, open the refrigerator/cooler door and as many locker doors as possible. Leaving as many of these areas open as possible will improve fresh air ventilation during the storage period.
- Place a mildew preventive system in the cabin area before it is closed for storage.
- Clean the exterior upholstery with a good vinyl cleaner and dry thoroughly. Spray the weather covers and boat upholstery with a spray disinfectant. Enclosed areas such as the refrigerator, shower basin, storage locker areas, etc. should also be sprayed with a disinfectant.

### 12.2 Winterizing

#### Fresh Water System

The entire fresh water system must be completely drained. Disconnect all hoses, check valves, etc. and blow all the water from the system. Make sure the water heater and fresh water tank are completely drained. Use very low air pressure only when blowing water from the system to prevent damage to components. The check valve mechanism built in the fresh water pump will not remove the water from the pump. Remove the outlet hose on the pump, turn it on and allow it to pump out any remaining water, approximately a cupful.

An alternate method is to use commercially available nontoxic, fresh water system antifreeze. After draining the potable water tank, lines and water heater, pour the antifreeze mixture into the fresh water tank, prime and operate the pump until the mixture flows from all fresh water faucets. Be sure to open ALL faucets, including the fresh water spray head in the stern bait station sink and the water supply valve for the head. Make sure antifreeze has flowed through all of the fresh water drains. Allow the antifreeze to fill the sink traps to trap odors from the waste tank.

The shower/cabin drain sump system must be winterized also. Clean debris from the drain and sump and flush for several minutes with fresh clean water. After the system is clean, pump the drain sump as dry as possible. Then pour a potable water antifreeze mixture into the shower drain until antifreeze has been pumped through the entire system and out of the thru-hull.

For additional information, refer to Plumbing Systems.

#### Raw Water System

Drain the raw water systems completely. Disconnect all hoses and blow the water from the system. Use very low air pressure only when blowing water from the system to prevent damage to components. The check valve mechanism built in the raw water

washdown pump, will not remove the water from the pump. Remove the outlet hose on the pump, turn it on and allow it to pump out any remaining water, approximately a cupful.

An alternate method is to use commercially available nontoxic, potable water system antifreeze. If antifreeze is used, pour the mixture into a pail and put the raw water intake lines into the solution. Run the pumps one at a time until the antifreeze solution is visible at all raw water faucets, discharge fittings and drains. Make sure antifreeze has flowed through all of the raw water drains.

Run the stern fishbox macerator pump until all the water is removed from the fishbox and the pump. To avoid damage to the pump, DO NOT run pump dry for more than ten seconds.

## Marine Toilet

Winterize the marine toilet following the manufacturer's winterizing procedures; follow the procedures exactly. Refer to the toilet owner's manual. Drain the intake and discharge hoses completely using low air pressure if necessary. The head holding tank and macerator discharge pump must be pumped dry and one gallon of potable water antifreeze poured into the tank through the deck waste pumpout fitting. After the antifreeze has been added to the holding tank, open the overboard discharge valve and activate the macerator pump until the antifreeze solution is visible at the discharge thru-hull.

## Bilge

Coat all metal components, wire busses, connector plugs (in the bilge), all strainers, seacocks and steering components with a protecting oil. The bilge pumps and bilge pump lines must be completely free of water and dried out when the boat is laid up for the winter in climates where freezing occurs. Compartments in the bilge that will not drain completely should be pumped out and then sponged until completely free of water. Dry the hull bilge and self-bailing cockpit

troughs. Water freezing in these areas could cause damage.

## Hardtop

Makes sure all drain holes in the legs are open and legs are completely free of water. Remove the canvas and thoroughly clean and store in a safe, dry place. Remove all electronics. Coat all wire connectors and bus bars in the helm compartment with a protecting oil.

Clean the aluminum frame with soap and water and dry thoroughly. Apply an aluminum metal protector to the entire frame to reduce corrosion and pitting.

## NOTICE

**Make sure the leg drain holes are clear when the boat is laid up for the winter. Water trapped inside the hardtop, tower or radar arch legs can freeze and cause the legs to split.**

## Covering for Winter Storage

Proper storage is very important to prevent serious damage to the boat. If the boat is stored outside, support and secure a storage cover properly over the boat. It is best to have a frame built over the boat to support the canvas. It should be a few inches wider than the boat so the canvas will clear the rails and allow passage of air. If this cover is fastened too tightly there will be inadequate ventilation and can lead to mildew, moisture accumulation, etc. Fasten the canvas down securely so wind cannot remove it or cause chafing of the hull superstructure. DO NOT store the boat in a damp storage enclosure. Excessive dampness can cause electrical problems, corrosion, and excessive mildew.

DO NOT use the bimini top or convertible top canvas in place of the winter storage cover. The life of these tops can be shortened if exposed to harsh weather elements for long periods.

DO NOT use an electric or fuel burning heating unit in the bilge area.

If the boat is to be stored indoors, make sure the building has enough ventilation and there is enough ventilation both inside the boat and around the boat. If the boat is to be stored indoors or outdoors, open all drawers, clothes lockers, cabinets, and doors a little. If possible, remove the upholstery, mattresses, clothing, and rugs.

### 12.3 Recommissioning

DO NOT operate the boat unless it is completely assembled. Keep all fasteners tight. Keep adjustments according to specifications.

Before launching the boat, make sure to install hull drain plug(s).

#### Reactivating The Boat After Storage:

- Charge and install the batteries.
- Install hull drain plug(s).
- Check the engines and generator for damage and follow the manufacturer's instructions for recommissioning.
- Check the mounting bolts of engines to make sure they are tight.
- Perform all routine maintenance.
- Check all hose clamps for tightness.
- Pump antifreeze from any systems winterized with antifreeze and flush several times with fresh water. Make sure all antifreeze is flushed from the water heater and it is filled with fresh water before it is activated.
- Check and lubricate the steering system.
- Clean and wash the boat.
- Install all upholstery, cushions and canvas.

#### After Launching:

- Check all water systems and the engine mounting bolts for leaks. Operate each system one at a time and check for leaks and proper operation.
- Check the bilge pump, manual and automatic switches.
- When the engines start, check the cooling system port below the engine cowling for a strong stream of water to ensure cooling pump is operating.
- Carefully monitor the gauges and check for leakage and abnormal noises.
- Operate boat at slow speeds until engine temperature stabilizes and all systems are operating normally.

## Glossary of Terms

**Aft:** In, near, or toward the stern of a boat.

**Aground:** A boat stuck on the bottom.

**Amidships:** In or toward the part of a boat midway between the bow and stern.

**Anchor:** A specially shaped heavy metal device designed to dig efficiently into the bottom under a body of water and hold a boat in place.

**Anchorage:** An area specifically designated by governmental authorities in which boats may anchor.

**Ashore:** On shore. **Astern:** Behind the boat, to move backwards.

**Athwartship:** At right angles to the center line of the boat.

**Barnacles:** Small, hard-shelled marine animals which are found in salt water attached to pilings, docks and bottoms of boats.

**Beam:** The breadth of a boat usually measured at its widest part.

**Bearing:** The direction of an object from the boat, either relative to the boat's direction or to compass degrees.

**Berth:** A bunk or a bed on a boat. **Bilge:** The bottom of the boat below the flooring.

**Bilge Pump:** A pump that removes water that collects in the bilge.

**Boarding:** Entering or climbing into a boat.

**Boarding Ladder:** Set of steps temporarily fitted over the side of a boat to assist persons coming aboard.

**Boat Hook:** Short shaft of wood or metal with a hook fitting at one end shaped to aid in extending one's reach from the side of the boat.

**Bow:** The front end of a boat's hull.

**Bow Line:** A line that leads forward from the bow of the boat.

**Bow Rail:** Knee high rails of solid tubing to aid in preventing people from falling overboard.

**Bridge:** The area from which a boat is steered and controlled.

**Bridge Deck:** A deck forward and usually above the cockpit deck.

**Broach:** When the boat is sideways to the seas and in danger of capsizing; a very dangerous situation that should be avoided.

**Bulkhead:** Vertical partition or wall separating compartments of a boat.

**Cabin:** Enclosed superstructure above the main deck level.

**Capsize:** When a boat lays on its side or turns over.

**Chock:** A deck fitting, usually of metal, with inward curving arms through which mooring or anchor lines are passed so as to lead them in the proper direction both onboard and off the boat.

**Cleat:** A deck fitting, usually of metal with projecting arms used for securing anchor and mooring lines.

**Closed Cooling System:** A separate supply of fresh water that is used to cool the engine and circulates only within the engine.

**Coaming:** A vertical piece around the edges of cockpit, hatches, etc. to stop water on deck from running below.

**Cockpit:** An open space, usually in the aft deck, outside of the cabin.

**Companionway:** Opening in the deck of a boat to provide access below.

**Compartment:** The interior of a boat divided off by bulkheads.

**Cradle:** A framework designed to support a boat as she is hauled out or stored.

**Cutlass Bearing:** A rubber bearing in the strut that supports the propeller shaft.

**Deck:** The floor-like platform of a boat that covers the hull.

**Displacement:** The volume of water displaced by the hull. The displacement weight is the weight of this volume of water.

**Draft:** The depth of water a boat needs to float.

**Dry Rot:** A fungus attack on wood areas.

**Dry-dock:** A dock that can be pumped dry during boat construction or repair.

**Electrical Ground:** A connection between an electrical connector and the earth.

**Engine Beds:** Sturdy structural members running fore and aft on which the inboard engines are mounted.

**EPIRB:** Emergency Position Indicating Radio Beacon. Operates as a part of a worldwide satellite distress system.

**Even Keel:** When a boat floats properly as designed.

**Fathom:** A measure of depth. One Fathom = 6 feet.

**Fender:** A soft object of rubber or plastic used to protect the topsides from scarring and rubbing against a dock or another vessel.

**Fend off:** To push or hold the boat off from the dock or another boat.

**Flying Bridge:** A control station above the level of the deck or cabin.

**Flukes:** The broad portions of an anchor which dig into the ground.

**Following Sea:** A sea that comes up from the stern and runs in the same direction that the boat is going.

**Fore:** Applies to the forward portions of a boat near the bow.

**Foundering:** When a boat fills with water and sinks.

**Freeboard:** The height from the waterline to the lowest part of the deck.

**Galley:** The kitchen of a boat.

**Grab Rail:** Hand-hold fittings mounted on cabin tops or sides for personal safety when moving around the boat, both on deck and below.

**Ground Tackle:** A general term including anchors, lines, and other gear used in anchoring.

**Grounds:** A boat touches the bottom.

**Gunwale:** The upper edge of a boat's side.

**Hand Rail:** Rail mounted on the boat, for grabbing with your hand, to steady you while walking about the boat.

**Harbor:** An anchorage which provides reasonably good protection for a boat, with shelter from wind and sea.

**Hatch:** An opening in the deck with a door or lid to allow for access down into a compartment of a boat.

**Head:** A toilet on a boat.

**Heat Exchanger:** Used to transfer the heat that is picked up by the closed cooling system to the raw cooling water.

**Helm:** The steering and control area of a boat.

**Hull:** The part of the boat from the deck down.

**Inboard:** A boat with the engine mounted within the hull of the boat. Also refers to the center of the boat away from the sides.

**Inboard/outboard:** Also stern drive or I/O. A boat with an inboard engine attached to an outboard drive unit.

**Keel:** A plate or timber plate running lengthwise along the center of the bottom of a boat.

**Knot:** Unit of speed indicating nautical miles per hour. 1 knot = 1 nautical mile per hour (1.15 miles per hour). A nautical mile is equal to one minute of latitude: 6076 feet. Knots times 1.15 equals miles per hour. Miles per hour times .87 equals knots.

**Lay-up:** To decommission a boat for the winter (usually in northern climates).

**Leeward:** The direction toward which the wind is blowing.

**Length On The Waterline (l.w.l.):** A length measurement of a boat at the waterline from the stern to where the hull breaks the water near the bow.

**Limber Hole:** A passage cut into the lower edges of floors and frames next to the keel to allow bilge water to flow to the lowest point of the hull where it can be pumped overboard.

**Line:** The term used to describe a rope when it is on a boat.

**Lists:** A boat that inclines to port or starboard while afloat.

**L.O.A.:** Boat length overall.

**Locker:** A closet, chest or box aboard a boat.

**Loran:** An electronic navigational instrument which monitors the boat's position using signals emitted from pairs of transmitting stations.

**Lunch hook:** A small light weight anchor typically used instead of the working anchor. Normally used in calm waters with the boat attended.

**Midships:** The center of the boat.

**Marina:** A protected facility primarily for recreational small craft.

**Marine Ways or Railways:** Inclined planes at the water's edge onto which boats are hauled.

**Moored:** A boat secured with cables, lines or anchors.

**Mooring:** An anchor permanently embedded in the bottom of a harbor that is used to secure a boat.



**Nautical Mile:** A unit of measure equal to one minute of latitude. (6076 feet)

**Nun Buoy:** A red or red-striped buoy of conical shape.

**Outboard:** A boat designed for an engine to be mounted on the transom. Also a term that refers to objects away from the center line or beyond the hull sides of a boat.

**Pad Eye:** A deck fitting consisting of a metal eye permanently secured to the boat.

**Pier:** A structure which projects out from the shoreline.

**Pile or Piling:** A long column driven into the bottom to which a boat can be tied.

**Pitching:** The fore and aft rocking motion of a boat as the bow rises and falls.

**Pitch:** The measure of the angle of a propeller blade. Refers to the theoretical distance the boat travels with each revolution of the propeller.

**P.F.D:** Personal Flotation Device.

**Port:** The left side of the boat when facing the bow.

**Porthole (port):** The opening in the side of a boat to allow the admittance of light and air.

**Propeller:** A device having two or more blades that is attached to the engine and used for propelling a boat.

**Propeller Shaft:** Shaft which runs from the back of the engine gear box, aft, through the stuffing box, shaft log, struts, and onto which the propeller is attached.

**Pyrotechnic Distress Signals:** Distress signals that resemble the brilliant display of flares or fireworks.

**Raw Water Cooled:** Refers to an engine cooling system that draws sea water in through a hull fitting or engine drive unit, circulates the water in the engine, and then discharges it overboard.

**Reduction Gear:** Often combined with the reverse gear so that the propeller turns at a slower rate than the engine.

**Reverse Gear:** Changes the direction of rotation of the propeller to provide thrust in the opposite direction for stopping the boat or giving it sternway.

**Roll:** A boat's sideways rotational motion in rough water.

**Rope Locker:** A locker, usually located in the bow of a boat, used for stowing the anchor line or chain.

**Rubrail:** Railing (often rubber or hard plastic) that runs along the boat's sheer to protect the hull when coming alongside docks, piers, or other boats.

**Rudder:** A movable flat surface that is attached vertically at or near the stern for steering.

**Sea anchor:** An anchor that does not touch the bottom. Provides drag to hold the bow in the most favorable position in heavy seas.

**Scupper:** An opening in the hull side or transom of the boat through which water on deck or in the cockpit is drained overboard.

**Seacock:** Safety valves installed just inside the thru-hull fittings and ahead of the piping or hose running from the fittings.

**Shaft Log:** Pipe through which the propeller shaft passes.

**Sheer:** The uppermost edge of the hull.

**Sling:** A strap which will hold the boat securely while being lifted, lowered, or carried.

**Slip:** A boat's berth between two pilings or piers.

**Sole:** The deck of a cockpit or interior cabin.

**Spring Line:** A line that leads from the bow aft or from the stern forward to prevent the boat from moving ahead or astern.

**Starboard:** The right side of a boat when facing the bow.

**Steerageway:** Sufficient speed to keep the boat responding to the rudder or drive unit.

**Stem:** The vertical portion of the hull at the bow.

**Stern:** The rear end of a boat.

**Stow:** To pack away neatly.

**Stringer:** Longitudinal members fastened inside the hull for additional structural strength.

**Strut:** Mounted to the hull which supports the propeller shaft in place.

**Strut Bearing:** See "cutlass bearing."

**Stuffing Box:** Prevents water from entering at the point where the propeller shaft passes through the shaft log.

**Superstructure:** Something built above the main deck level.

**Swamps:** When a boat fills with water from over the side.

**Swimming Ladder:** Much the same as the boarding ladder except that it extends down into the water.

**Taffrail:** Rail around the rear of the cockpit.

**Thru-hull:** A fitting used to pass fluids (usually water) through the hull surface, either above or below the waterline.

**Topsides:** The side skin of a boat between the waterline or chine and deck.

**Transom:** A flat stern at right angles to the keel.

**Travel Lift:** A machine used at boat yards to hoist boats out of and back into the water.

**Trim:** Refers to the boat's angle or the way it is balanced.

**Trough:** The area of water between the crests of waves and parallel to them.

**Twin-Screw Craft:** A boat with two propellers on two separate shafts.

**Underway:** When a boat moves through the water.

**Wake:** Disrupted water that a boat leaves astern as a result of its motion.

**Wash:** The flow of water that results from the action of the propeller or propellers.

**Waterline:** The plane of a boat where the surface of the water touches the hull when it is afloat on even keel.

**Watertight Bulkhead:** Bulkheads secured so tightly so as not to let water pass.

**Wharf:** A structure generally parallel to the shore.

**Working Anchor:** An anchor carried on a boat for most normal uses. Refers to the anchor used in typical anchoring situations.

**Windlass:** A winch used to raise and lower the anchor.

**Windward:** Toward the direction from which the wind is coming.

**Yacht Basin:** A protected facility primarily for recreational small craft.

**Yaw:** When a boat runs off her course to either side.

# Maintenance Schedule

# Section B

Maintenance	Each Use	Weekly	Monthly	Semi-Annually	Yearly	As Nedeed
Clean hull below the waterline				X		
Bottom paint					X	X
Check sacrificial anodes			X			
Replace sacrificial anodes					X	
Wash boat canvas& hardware	X		X			
Wax exterior gelcoat				X		X
Clean & protect hardware						X
Polish & protect plastic glass					X	X
Clean exterior upholstery	X					X
Clean cabin & interior upholstery						X
Flush engine with fresh water	X					
Spray metal components in bilge with a protector			X			
Clean bilge				X		X
Check bilge for leaks	X		X			
Inspect & operate thru-hull valves			X			
Inspect steering & control systems	X					
Service steering & control systems				X		
Inspect fuel system for leaks	X					
Inspect & service fuel system				X		
Inspect fuel tank vents & screens					X	
Replace fuel filters					X	
Lubricate fuel fill O-rings			X			
Inspect fire extinguisher			X			
Test bilge pump auto switches	X					
Inspect & protect electrical components, wire & battery connections				X		
Check battery electrolyte & service			X			
Test and inspect AC electrical system & shore power cord				X		
Inspect water systems for leaks				X		
Check neutral safety switch	X					

Date	Hours	Dealer	Service/Repairs





Boating Accident Report

DEPARTMENT OF TRANSPORTATION U.S. COAST GUARD C.G. 1865 (REV. 1/88)		<b>BOATING ACCIDENT REPORT</b>				FORM APPROVED OMB NO.211-0010			
<small>The operator/owner of a vessel used for recreational purposes is required to file a report in writing whenever an accident results in: loss of life or disappearance from a vessel, or an injury which requires medical treatment beyond first aid: or property damage in excess of \$200 or complete loss of the vessel. Reports in death and injury cases must be submitted within 48 hours. Reports in other cases must be submitted within 10 days. Reports must be submitted to reporting authority in the state where the accident occurred. This form is provided to assist the operator in filing the required written report.</small>									
<b>COMPLETE ALL BLOCKS</b> (indicate those not applicable by "NA")									
NAME AND ADDRESS OF OPERATOR			AGE OF OPERATOR DATE OF BIRTH		OPERATOR'S EXPERIENCE This type of boat          Other boat operating Exp. [ ] Under 20 Hours       [ ] Under 20 Hours [ ] 20 to 100 Hours     [ ] 20 to 100 Hours [ ] 100 to 500 Hours   [ ] 100 to 500 Hours [ ] Over 500 Hours     [ ] Over 500 Hours				
OPERATOR TELEPHONE NUMBER			OWNER TELEPHONE NO.						
NAME AND ADDRESS OF OWNER			RENTED BOAT [ ] YES [ ] NO	NUMBER OF PERSONS ON BOARD	FORMAL INSTRUCTION IN BOATING SAFETY [ ] None   [ ] State   [ ] U.S. Power Squadrons [ ] USCG Auxiliary   [ ] American Red Cross [ ] Other (Specify) _____				
<b>VESSEL NO.</b> (this vessel)									
BOAT REGISTER NO.	BOAT NAME	BOAT MAKE	BOAT MODEL	MFR HULL IDENTIFICATION NO.					
TYPE OF BOAT [ ] Open Motorboat [ ] Cabin Motorboat [ ] Auxiliary Sail [ ] Sail (only) [ ] Rowboat [ ] Canoe [ ] Other (Specify)	HULL MATERIAL [ ] Wood [ ] Aluminum [ ] Steel [ ] Fiberglass [ ] Rubber/vinyl [ ] Other (Specify)	ENGINE [ ] Outboard [ ] Inboard gasoline [ ] Inboard diesel [ ] Inboard-outdrive [ ] Jet [ ] Other (Specify)	PROPULSION No. of engines _____ Horse Power (total) _____ Type of fuel _____ Has boat had a Safety Examination? [ ] Outboard [ ] NO For current year? [ ] YES [ ] NO Year _____ Indicate whether [ ] USCG Auxiliary Courtesy Marine Exam [ ] State/local examination [ ] Other	CONSTRUCTION Length _____ Year built (boat) _____					
<b>ACCIDENT DATA</b>									
DATE OF ACCIDENT	TIME	NAME OF BODY OF WATER		LOCATION (Give location precisely)	Lat Long				
STATE	NEAREST CITY OR TOWN			COUNTY					
WEATHER [ ] Clear    [ ] Rain [ ] Cloudy   [ ] Snow [ ] Fog      [ ] Hazy	WATER CONDITIONS [ ] Calm (waves less than 6") [ ] Choppy (waves 6" to 2') [ ] Rough (greater than 6") [ ] Strong Current		TEMPERATURE (Estimate) Air _____ F° Water _____ F°	WIND [ ] None [ ] Light (0 - 6mph) [ ] Moderate (7 - 14 mph) [ ] Strong (15 - 25 mph) [ ] Storm (Over 25 mph)	VISIBILITY DAY       NIGHT [ ] Good    [ ] [ ] Fair     [ ] [ ] Poor    [ ]				
OPERATION AT TIME OF ACCIDENT (Check all applicable) [ ] Commercial Activity    [ ] Drifting [ ] Cruising                    [ ] At Anchor [ ] Maneuvering              [ ] Tied to Dock [ ] Approaching Dock      [ ] Fueling [ ] Leaving Dock              [ ] Fishing [ ] Water Skiing              [ ] Hunting [ ] Racing                      [ ] Skin Diving/ [ ] Towing                      Swimming [ ] Other (Specify)            [ ] Being Towed		TYPE OF ACCIDENT (Check all applicable) [ ] Grounding                 [ ] Collision with [ ] Capsizing                 Fixed Object [ ] Flooding                    [ ] Collision with [ ] Sinking                     Floating Object [ ] Fire or explosion (fuel)   [ ] Falls Overboard [ ] Fire or explosion (Other than fuel) [ ] Falls in boat [ ] Hit by Boat or [ ] Fallen Skier                Propeller [ ] Collision with Vessel     [ ] Other (Specify)			WHAT IN YOUR OPINION CONTRIBUTED TO THE ACCIDENT (Check all applicable) [ ] Weather                    [ ] Alcohol use [ ] Excessive speed          [ ] Drug use [ ] No Proper Lookout       [ ] Fault of Hull [ ] Restricted Vision         [ ] Fault of Machinery [ ] Overloading               [ ] Fault of Equipment [ ] Improper Loading        [ ] Hunting [ ] Racing                      [ ] Operator Inexperience [ ] Hazardous Waters       [ ] Operator Inattention [ ] Other (Specify)				
<b>PERSONAL FLOTATION DEVICES (PFD'S)</b>				<b>PROPERTY DAMAGE</b>		<b>FIRE EXTINGUISHERS</b>			
Was the boat adequately equipped with COAST GUARD APPROVED FLOTATION DEVICES? [ ] Yes [ ] No Were they accessible?           [ ] Yes [ ] No Were they serviceable?         [ ] Yes [ ] No Were they used by survivors?   [ ] Yes [ ] No What type? [ ] I, [ ] II, [ ] III, [ ] IV, [ ] V (specify) _____ Were PFD's properly used?     [ ] Yes [ ] No Adjusted                    [ ] Yes [ ] No Sized                         [ ] Yes [ ] No				Was the vessel carrying <u>NON</u> approved flotation devices? [ ] Yes [ ] No Were they accessible?          [ ] Yes [ ] No Were they used?                 [ ] Yes [ ] No If Yes, indicate kind.		Estimated amount This boat \$ _____ Other boat \$ _____ Other Property \$ _____		Were they used? (If yes, list Type(s) and number used.) [ ] Yes [ ] No [ ] NA Types:	
				DESCRIBE PROPERTY DAMAGE					
				NAME AND ADDRESS OF OWNER OF DAMAGED PROPERTY					
<small>Include any comments of PFD's under ACCIDENT DESCRIPTION on other side of form</small>									



# Section C

# Boating Accident Report

If more than 3 fatalities and/or injuries, attach additional form(s)					
<b>DECEASED</b>					
NAME	ADDRESS	DATE OF BIRTH	WAS VICTIM? <input type="checkbox"/> Swimmer <input type="checkbox"/> Non Swimmer	DEATH CAUSED BY <input type="checkbox"/> Drowning <input type="checkbox"/> Other <input type="checkbox"/> DISAPPEARANCE	WAS PFD WORN? <input type="checkbox"/> Yes <input type="checkbox"/> No What Type?
NAME	ADDRESS	DATE OF BIRTH	WAS VICTIM? <input type="checkbox"/> Swimmer <input type="checkbox"/> Non Swimmer	DEATH CAUSED BY <input type="checkbox"/> Drowning <input type="checkbox"/> Other <input type="checkbox"/> DISAPPEARANCE	WAS PFD WORN? <input type="checkbox"/> Yes <input type="checkbox"/> No What Type?
NAME	ADDRESS	DATE OF BIRTH	WAS VICTIM? <input type="checkbox"/> Swimmer <input type="checkbox"/> Non Swimmer	DEATH CAUSED BY <input type="checkbox"/> Drowning <input type="checkbox"/> Other <input type="checkbox"/> DISAPPEARANCE	WAS PFD WORN? <input type="checkbox"/> Yes <input type="checkbox"/> No What Type?
<b>INJURED</b>					
NAME	ADDRESS	DATE OF BIRTH	NATURE OF INJURY	MEDICAL TREATMENT	
NAME	ADDRESS	DATE OF BIRTH	NATURE OF INJURY	MEDICAL TREATMENT	
NAME	ADDRESS	DATE OF BIRTH	NATURE OF INJURY	MEDICAL TREATMENT	
<b>ACCIDENT DESCRIPTION</b>					
DESCRIBE WHAT HAPPENED (Sequence of events. Include Failure of Equipment. If diagram is needed, attach separately. Continue on additional sheets if necessary. Include any information regarding the involvement of alcohol and/or drugs in causing or contributing to the accident. Include any descriptive information about the use of PFD's.)					
<b>VESSEL NO. 2 (if more than 2 vessels, attach additional form (s))</b>					
Name of Operator		Address		Boat Number	
Telephone Number				Boat Name	
Name of Owner		Address			
<b>WITNESSES</b>					
Name		Address		Telephone Number	
Name		Address		Telephone Number	
Name		Address		Telephone Number	
<b>WITNESSES</b>					
SIGNATURE		Address		Telephone Number	
QUALIFICATION (Check One) <input type="checkbox"/> Operator <input type="checkbox"/> Owner <input type="checkbox"/> Investigator <input type="checkbox"/> Other				Date Submitted	
(do not use) - FOR REPORTING AUTHORITY REVIEW (use agency date stamp)					
Causes based on (check one) <input type="checkbox"/> This report <input type="checkbox"/> Investigation and this report <input type="checkbox"/> Investigation <input type="checkbox"/> Could not be determined		Name of Reviewing Office		Date Received	
Primary Cause of Accident		Secondary Cause of Accident		Reviewed By	



www.cgaux.org

## FLOAT PLAN

**INSTRUCTIONS:** Complete this plan before you go boating and leave it with a reliable person who can be depended upon to notify the Coast Guard, or other rescue agency, should you not return or check-in as planned. If you have a change of plans, or will be delayed, notify the person holding your Float Plan. Finally, close your plan by notifying the holder you have arrived home safely and if the holder has reported you overdue, notify all applicable rescue authorities of your safe return.



www.uscgboating.org

**Do NOT file this plan with the Coast Guard**

### VESSEL

#### IDENTIFICATION:

Name & Hailing Port \_\_\_\_\_  
 Document / Registration No. \_\_\_\_\_ HIN \_\_\_\_\_  
 Year, Make & Model \_\_\_\_\_  
 Length \_\_\_\_\_ Type \_\_\_\_\_ Draft \_\_\_\_\_ Hull Mat. \_\_\_\_\_  
 Hull & Trim Colors \_\_\_\_\_  
 Prominent Features \_\_\_\_\_

#### COMMUNICATION:

Radio Call Sign / Number \_\_\_\_\_  
 DSC MMSI No. \_\_\_\_\_  
 Radio-1: Type \_\_\_\_\_ Ch. / Freq. Monitored \_\_\_\_\_  
 Radio-2: Type \_\_\_\_\_ Ch. / Freq. Monitored \_\_\_\_\_  
 Cell / Satellite \_\_\_\_\_  
 Email \_\_\_\_\_

#### PROPULSION:

Primary-- Type \_\_\_\_\_ Eng. \_\_\_\_\_ Fuel Capacity \_\_\_\_\_  
 Auxiliary--Type \_\_\_\_\_ Eng. \_\_\_\_\_ Fuel Capacity \_\_\_\_\_

#### NAVIGATION: (Check all onboard)

Compass  Radar  GPS / DGPS  Depth Sounder  
 Charts  Maps  \_\_\_\_\_

### SAFETY & SURVIVAL

#### VISUAL DISTRESS SIGNALS:

Electric Distress Light (night only)  
 Flag (day only)  
 Flare, Aerial (day & night)  
 Flare, Handheld (day & night)  
 Signal Mirror (day only)  
 Smoke (day only)

#### AUDIBLE DISTRESS SIGNALS:

Bell  
 Horn  
 Whistle

#### EPIRB:

UIN\* \_\_\_\_\_

#### ADDITIONAL GEAR:

Anchor - Line length \_\_\_\_\_  Food for \_\_\_\_\_ days / person  
 Dewatering device  Water for \_\_\_\_\_ days / person  
 Exposure suits  
 Fire Extinguisher  
 Flashlight / Searchlight  
 Raft / Dinghy

### PERSONS ONBOARD

#### OPERATOR:

Name \_\_\_\_\_ Has experience with:  this vessel;  the boating area(s).  
 Address \_\_\_\_\_ Home Phone \_\_\_\_\_  
 City \_\_\_\_\_ State \_\_\_\_\_ Zip Code \_\_\_\_\_ Vehicle (Year, Make & Model) \_\_\_\_\_  
 Age \_\_\_\_\_ Gender \_\_\_\_\_ PFD  PLB UIN\* \_\_\_\_\_ Vehicle License No. \_\_\_\_\_ Trailer   
 Note \_\_\_\_\_ Vehicle parked at \_\_\_\_\_  
 Float Plan Note \_\_\_\_\_

#### PASSENGERS / CREW: (Identify all on board)

Name	Home Phone	Age	Gender	PFD	Note
1. _____	_____	_____	_____	<input type="checkbox"/>	_____
2. _____	_____	_____	_____	<input type="checkbox"/>	_____
3. _____	_____	_____	_____	<input type="checkbox"/>	_____
4. _____	_____	_____	_____	<input type="checkbox"/>	_____
5. _____	_____	_____	_____	<input type="checkbox"/>	_____
6. _____	_____	_____	_____	<input type="checkbox"/>	_____
7. _____	_____	_____	_____	<input type="checkbox"/>	_____
8. _____	_____	_____	_____	<input type="checkbox"/>	_____
9. _____	_____	_____	_____	<input type="checkbox"/>	_____
10. _____	_____	_____	_____	<input type="checkbox"/>	_____
11. _____	_____	_____	_____	<input type="checkbox"/>	_____
12. _____	_____	_____	_____	<input type="checkbox"/>	_____

Passenger PLB UIN\*  
 (Not listed in a specific order)

\_\_\_\_\_  
 \_\_\_\_\_  
 \_\_\_\_\_  
 \_\_\_\_\_  
 \_\_\_\_\_  
 \_\_\_\_\_  
 \_\_\_\_\_  
 \_\_\_\_\_  
 \_\_\_\_\_  
 \_\_\_\_\_  
 \_\_\_\_\_  
 \_\_\_\_\_

If you have a genuine concern for the safety or welfare of the persons onboard this vessel that have not returned or checked-in, in a reasonable amount of time, then follow the step-by-step instructions on the Boating Emergency Guide™ located on the last page of this Float Plan.

(\*) EPIRB and PLB registration required by Federal regulations. [www.beaconregistration.noaa.gov](http://www.beaconregistration.noaa.gov)



www.cgaux.org

## FLOAT PLAN continued

INSTRUCTIONS: Complete this plan before you go boating and leave it with a reliable person who can be depended upon to notify the Coast Guard, or other rescue agency, should you not return or check-in as planned. If you have a change of plans, or will be delayed, notify the person holding your Float Plan. Finally, close your plan by notifying the holder you have arrived home safely and if the holder has reported you overdue, notify all applicable rescue authorities of your safe return.

**Do NOT file this plan with the U.S. Coast Guard**



www.uscgboating.org

### CONTACTS

Contact 1 \_\_\_\_\_ Phone Number \_\_\_\_\_  
 Contact 2 \_\_\_\_\_ Phone Number \_\_\_\_\_  
 Rescue Authority \_\_\_\_\_ Phone Number \_\_\_\_\_

### ITINERARY

		DATE	TIME	LOCATION / WAYPOINT	MODE OF TRAVEL	REASON FOR STOP	CHECK-IN TIME
1	Depart						
	Arrive						
2	Depart						
	Arrive						
3	Depart						
	Arrive						
4	Depart						
	Arrive						
5	Depart						
	Arrive						
6	Depart						
	Arrive						
7	Depart						
	Arrive						
8	Depart						
	Arrive						
9	Depart						
	Arrive						
10	Depart						
	Arrive						
11	Depart						
	Arrive						
12	Depart						
	Arrive						
13	Depart						
	Arrive						
14	Depart						
	Arrive						
15	Depart						
	Arrive						
16	Depart						
	Arrive						
17	Depart						
	Arrive						
18	Depart						
	Arrive						
19	Depart						
	Arrive						
20	Depart						
	Arrive						
21	Arrive						

If you have a genuine concern for the safety or welfare of the persons onboard this vessel that have not returned or checked-in, in a reasonable amount of time, then follow the step-by-step instructions on the Boating Emergency Guide™ located on the last page of this Float Plan.

# Float Plan

## USCG Float Plan - BOATING EMERGENCY GUIDE™

**BEFORE YOU BEGIN** – This guide is designed to work either with or without a Float Plan. You will need the following items: 1) the Float Plan, if one was given to you; 2) a pen or pencil; 3) a clean sheet of paper or writing tablet; and 4) your local telephone directory.

**Step 1:** Do you have a genuine concern for the safety or welfare of any persons who have not returned or checked-in, in a reasonable amount of time?

If **yes**, then continue with **Step 2**. Otherwise **STOP** -- no further action is required at this time.

**Step 2:** Were you given a prepared Float Plan by anyone on board the vessel?

If **yes**, then continue with **Step 3**. Otherwise, go to **Step 5**.

**Step 3:** Locate the Contacts at the top of page 2 on the Float Plan. Call Contact number 1...

IF CONTACT #1	THEN					
Answers phone	Take notes during your conversation.					
	<ol style="list-style-type: none"> <li>Let the person know you are responding to a late return or check-in by the individuals designated on the Float Plan.</li> <li>Determine if the person you are talking to, or anyone else at that location, has recently had contact with anyone on the vessel, and when and where that contact occurred.</li> <li>Are you still concerned about the safety or welfare of any persons on board the vessel? <table border="1" style="margin-left: 20px;"> <thead> <tr> <th>IF</th> <th>THEN</th> </tr> </thead> <tbody> <tr> <td>Yes</td> <td>Continue with <b>Step 4</b>.</td> </tr> <tr> <td>No</td> <td><b>STOP</b>. No further action is required.</td> </tr> </tbody> </table> </li> </ol>	IF	THEN	Yes	Continue with <b>Step 4</b> .	No
IF	THEN					
Yes	Continue with <b>Step 4</b> .					
No	<b>STOP</b> . No further action is required.					
Does not answer phone	Continue with <b>Step 4</b> .					

**Step 4:** Call Contact number 2...

IF CONTACT #2	THEN					
Answers phone	Take notes during your conversation.					
	<ol style="list-style-type: none"> <li>Let the person know you are responding to a late return or check-in by the individuals designated on the Float Plan.</li> <li>Determine if the person you are talking to, or anyone else at that location, has recently had contact with anyone on the vessel, and when and where that contact occurred.</li> <li>Are you still concerned about the safety or welfare of any persons on board the vessel? <table border="1" style="margin-left: 20px;"> <thead> <tr> <th>IF</th> <th>THEN</th> </tr> </thead> <tbody> <tr> <td>Yes</td> <td>Continue with <b>Step 6</b>.</td> </tr> <tr> <td>No</td> <td><b>STOP</b>. No further action is required.</td> </tr> </tbody> </table> </li> </ol>	IF	THEN	Yes	Continue with <b>Step 6</b> .	No
IF	THEN					
Yes	Continue with <b>Step 6</b> .					
No	<b>STOP</b> . No further action is required.					
Does not answer phone	Continue with <b>Step 6</b> .					

**Step 5:** Using the checklist below, jot down only what you know about each item:

**DO NOT SPECULATE.** Incorrect information may mislead Search and Rescue personnel; add to the overall search and rescue time; and adversely affect the outcome.

- Period of time the vessel has been overdue.
- Purpose of the trip or voyage.
- Description of vessel. (Type, size, color, features, etc.)
- Vessel's departure point and destination.
- Places the vessel planned to stop during transit.
- Navigation equipment aboard. (Examples: GPS, radar, compass, sounder, etc.)
- Number of persons aboard. Relevant characteristics such as dependability, reliability, etc.
- Was the vessel initially docked or moored or did a vehicle tow it to a launch point?
- License plate number and description of the tow vehicle p and/or the passenger's transport vehicle.
- Communications equipment aboard, including type of radio and frequencies monitored, cellular or satellite telephone numbers of individuals, etc.
- Additional points of contact along the vessel's planned route.
- Operator and/or a passenger/crew member absolutely had to be back at the scheduled return time.
- Call your local Rescue Authority that responds to marine emergencies (Police, Sheriff, Constable, First responder, etc.).

Go to **Step 6-2**.

**Step 6:**

- Call the Rescue Authority contact at the top of page 2 on the Float Plan.
- Tell the dispatcher you are responding to a late return or check-in by the persons on board the vessel.
- The dispatcher will instruct you from there.

**Note:** The dispatcher will provide you with the necessary contact or agency connection to get a search and rescue mission started. This puts you in direct contact with the agency conducting the actual search and rescue, eliminating unnecessary middlemen.  
The dispatcher will tell you if he/she desires a follow-up call on the outcome of the rescue.

- Continue with **Step 7**.

**Step 7:** Be patient... you've done everything you can possibly do for now. It is important to keep the telephone available so emergency personnel can contact you with additional information and/or questions concerning the search and rescue effort.

**STOP -- End of Guide**

Provided as a courtesy by:

**Pursuit Boats**

Ft. Pierce, FL  
(772) 465-600

www.pursuitboats.com

Get a Vessel Safety Check before you go boating.



The USCG Float Plan is the official Float Plan of the U.S. Coast Guard and U.S. Coast Guard Auxiliary. For more information visit:

www.floatplancentral.org



## Troubleshooting Guide

Problem	Cause and Solution
<b>Control Systems</b>	
<p><b>Hydraulic Steering is slow to respond and erratic.</b></p>	<ul style="list-style-type: none"> <li>• Steering system is low on fluid. Fill and bleed system.</li> <li>• Steering system has air in it. Fill and bleed system.</li> <li>• A component in the steering system is binding. Check and adjust or repair binding component.</li> <li>• Engine steering cylinder is binding. Grease spindle.</li> </ul>
<p><b>The boat wanders and will not hold a course at cruise speeds.</b></p>	<ul style="list-style-type: none"> <li>• There could be air in the steering system. Fill &amp; bleed the system.</li> <li>• The engine steering tab is corroded or out of adjustment. Replace or adjust steering tab.</li> <li>• Engine steering cylinder is binding. Grease spindle.</li> </ul>
<p><b>The engine will not start with the shift control lever in neutral.</b></p>	<ul style="list-style-type: none"> <li>• The control is out of adjustment &amp; not activating the neutral safety cut out switch.</li> <li>• The shift control lever is not in the neutral detent. Try moving the shift lever slightly.</li> <li>• There is a loose wire on the neutral safety switch on the transmission. Inspect wires and repair loose connections.</li> <li>• The starter or ignition switch is bad.</li> </ul>
<b>Performance Problems</b>	
<p><b>Boat is sluggish and has lost speed and RPM.</b></p>	<ul style="list-style-type: none"> <li>• The boat may be need to have marine growth cleaned from hull and running gear.</li> <li>• Propeller may be damaged &amp; need repair.</li> <li>• Weeds or line around the propeller. Clean propeller.</li> <li>• Boat is overloaded. Reduce load.</li> <li>• Check for excessive water in the bilge. Pump out bilge &amp; find &amp; correct the problem.</li> <li>• The throttle adjustments has changed and the engine is not getting full throttle. Adjust the throttle.</li> </ul>

<b>Problem</b>	<b>Cause and Solution</b>
<b>The boat vibrates at cruising speeds.</b>	<ul style="list-style-type: none"> <li>• Propeller may be damaged and need repair.</li> <li>• The propeller or propeller shaft is bent. Repair or replace damaged components.</li> <li>• The running gear is fouled by marine growth or rope. Clean running gear.</li> <li>• The engine is not trimmed properly. Trim the engine.</li> </ul>
<b>Engine Problems</b>	
<b>The engine is running too hot.</b>	<ul style="list-style-type: none"> <li>• The engine raw water pick-up strainer up is clogged with marine growth. Clean pick-up.</li> <li>• The engine raw water pump impeller is worn or damaged. Repair the pump.</li> <li>• The engine thermostat is faulty and needs to be replaced.</li> </ul>
<b>The engine alternator is not charging properly.</b>	<ul style="list-style-type: none"> <li>• The battery cable is loose or corroded. Clean and tighten battery cables.</li> <li>• The alternator is not charging and must be replaced.</li> <li>• The engine battery isolator in the charging system is not working properly. Replace the isolator.</li> <li>• The battery is defective. Replace the battery.</li> </ul>
<b>The engine suddenly will not operate over 2000 RPM.</b>	<ul style="list-style-type: none"> <li>• The engine emergency system has been activated. The onboard computer has sensed a problem and has limited the RPM to protect the engine. Find &amp; correct the problem.</li> <li>• The tachometer is bad and needs to be replaced.</li> </ul>

Problem	Cause and Solution
<p><b>The engine is loosing RPM. The boat is not overloaded and the hull bottom and running gear are clean and in good condition.</b></p>	<ul style="list-style-type: none"> <li>• The engine may be having a problem with a sticky anti-siphon valve, located in the fuel line near the fuel tank, that is restricting the fuel flow. Remove &amp; clean or replace the anti-siphon valve.</li> <li>• The remote gasoline fuel filter could be dirty. Inspect and replace the fuel filter.</li> <li>• The primary fuel filter on the engine may be dirty. Inspect and replace the fuel filter.</li> <li>• The electronic engine control system on the engine is malfunctioning. Repair the engine control system.</li> <li>• The fuel injection system on the engine is malfunctioning. Repair the fuel injection system.</li> </ul>
<p><b>Accessory Problems</b></p>	
<p><b>The livewell pump runs, but does not pump water.</b></p>	<ul style="list-style-type: none"> <li>• The strainer on the intake scoop is clogged preventing the water from getting to the pump. Put the boat in reverse to clean the strainer.</li> <li>• There is an air lock in the system. Run the boat above 15 m.p.h. and the pick-up scoop will force the air lock past the pump and prime the system.</li> <li>• The thru-hull valve is not open. Open valve.</li> <li>• The valve in the livewell is not open. Open the valve in the livewell.</li> </ul>
<p><b>The automatic float switch on the bilge pump raises but does not activate the pump.</b></p>	<ul style="list-style-type: none"> <li>• The in-line fuse near the battery switch has blown. Replace the fuse.</li> <li>• The pump impeller is jammed by debris. Clean pump impeller housing.</li> <li>• The pump is defective. Replace pump.</li> </ul>





# DC 246 (D4) 12DC MDP FACE

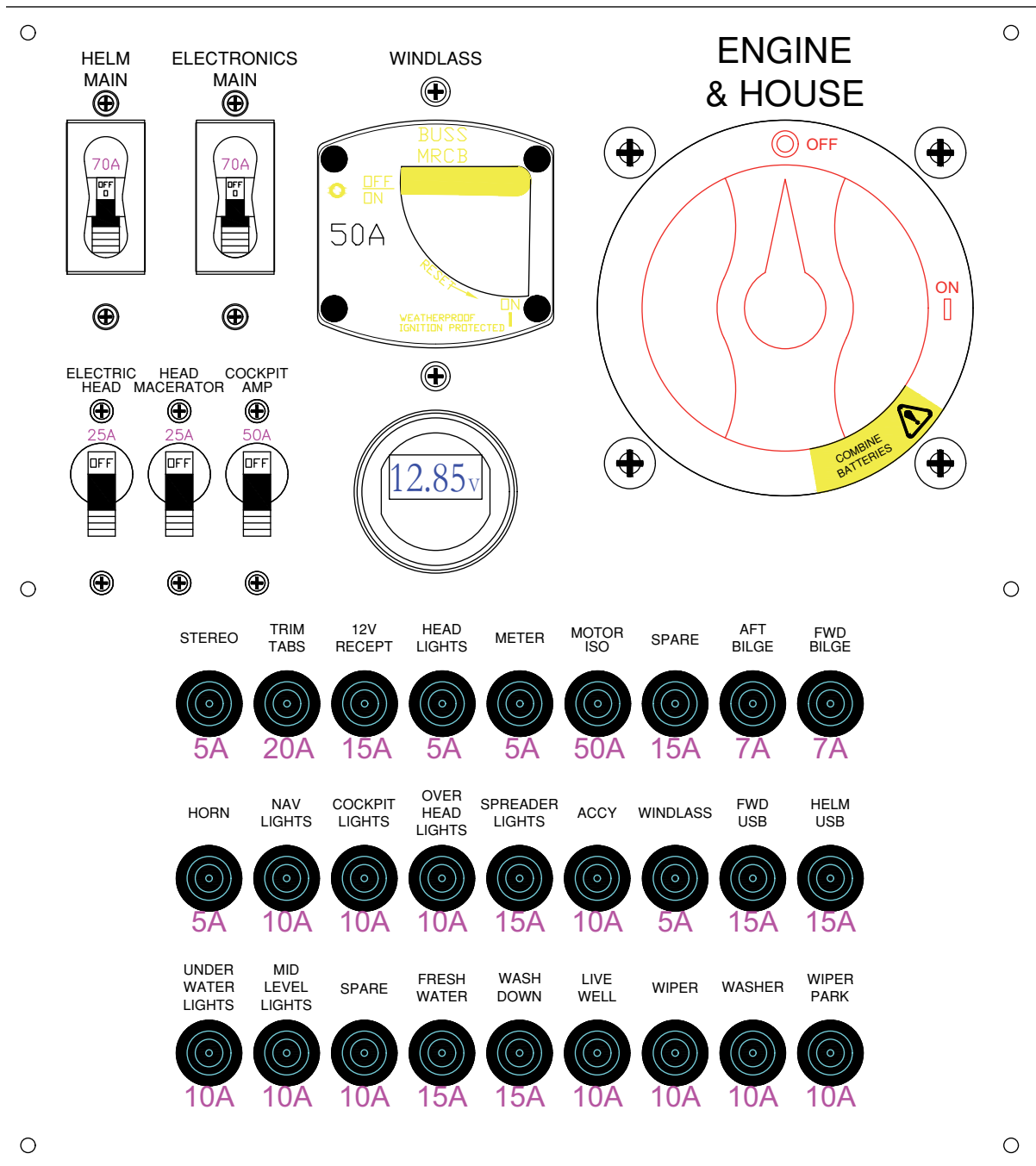

## DC 246 (D4) 12DC MDP BACK SIDE WIRING

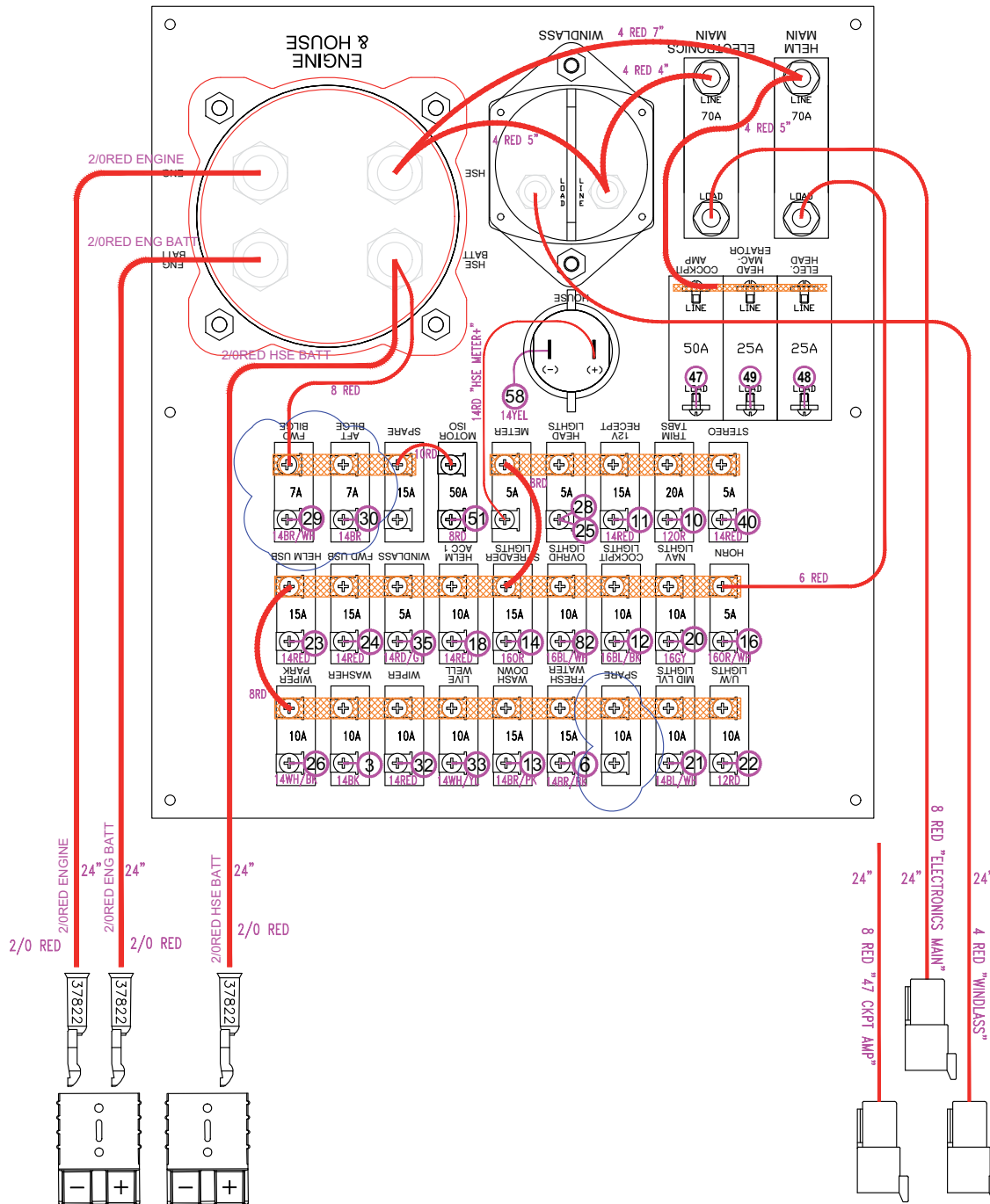

DC 246 (D4) 12DC MDP TERMINATIONS

HC1 HARNESS CONNECTION #1

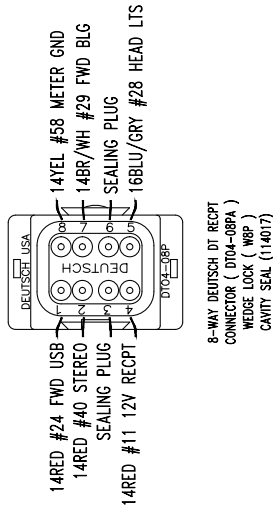

HC2 - HARNESS CONNECT #2

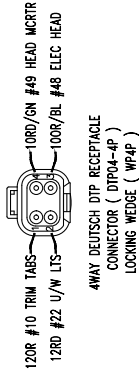

HARNESS CONNECTION #3

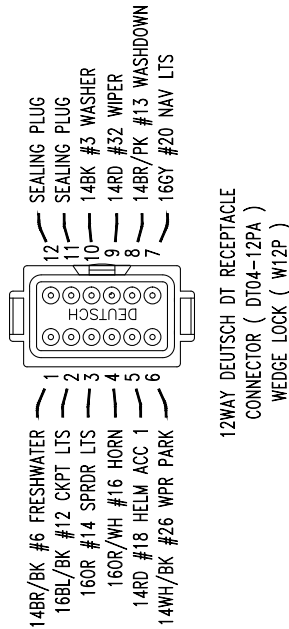

SW1 - TO D3 HELM SW PANEL

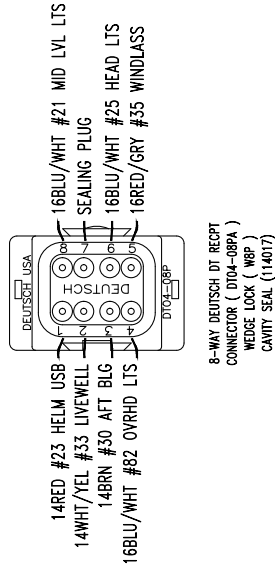

MOTOR ISOLATOR

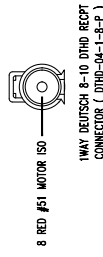

ELECTRONICS MAIN

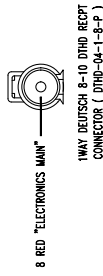

WINDGLASS

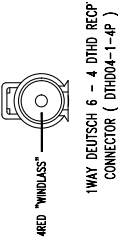

COCKPIT AMP

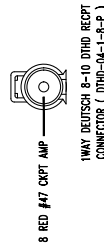

# DC 246 (D4) 3309811HELM PANEL FACE

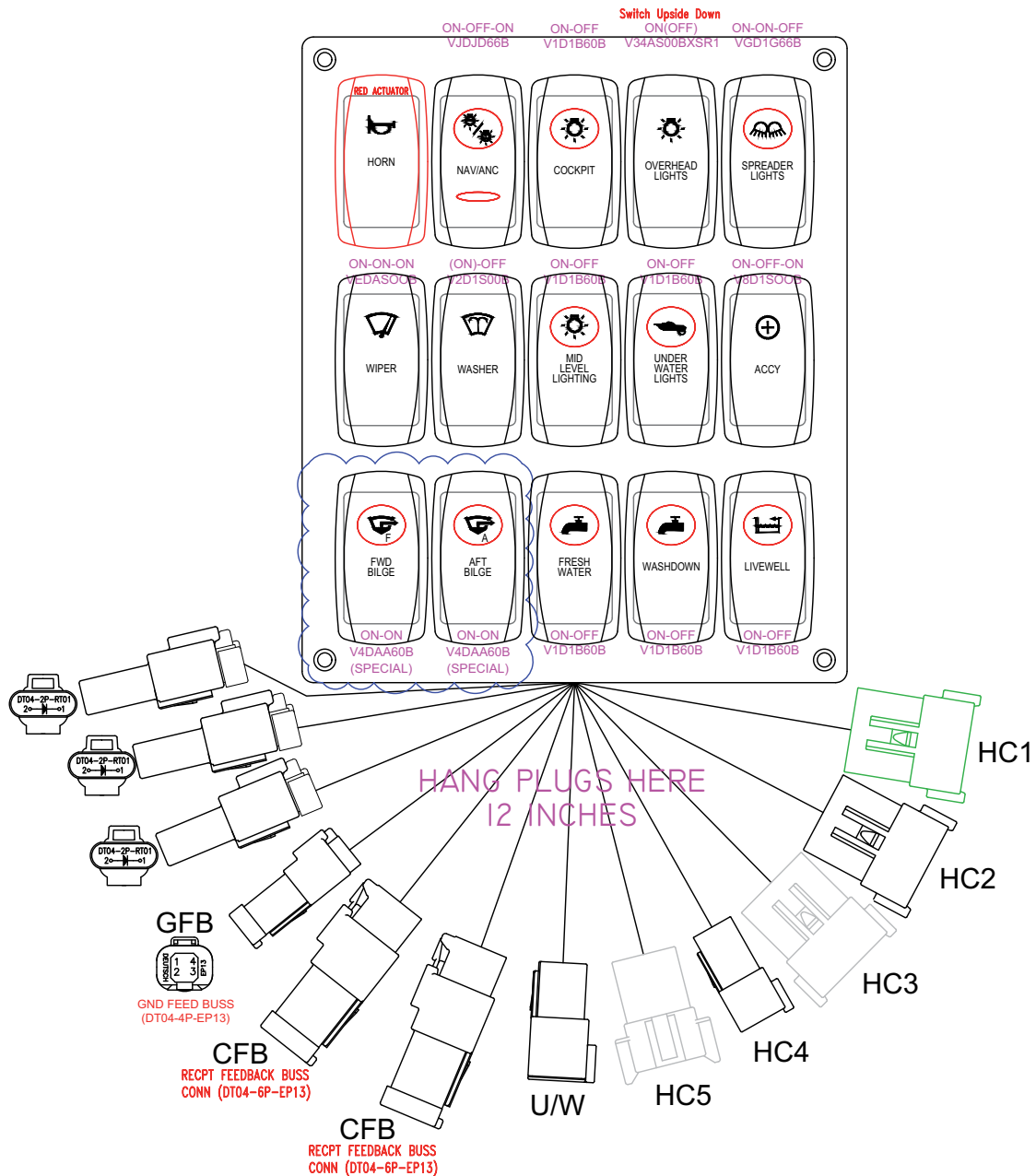

DC 246 (D4) 3309811 HELM PANEL BACK

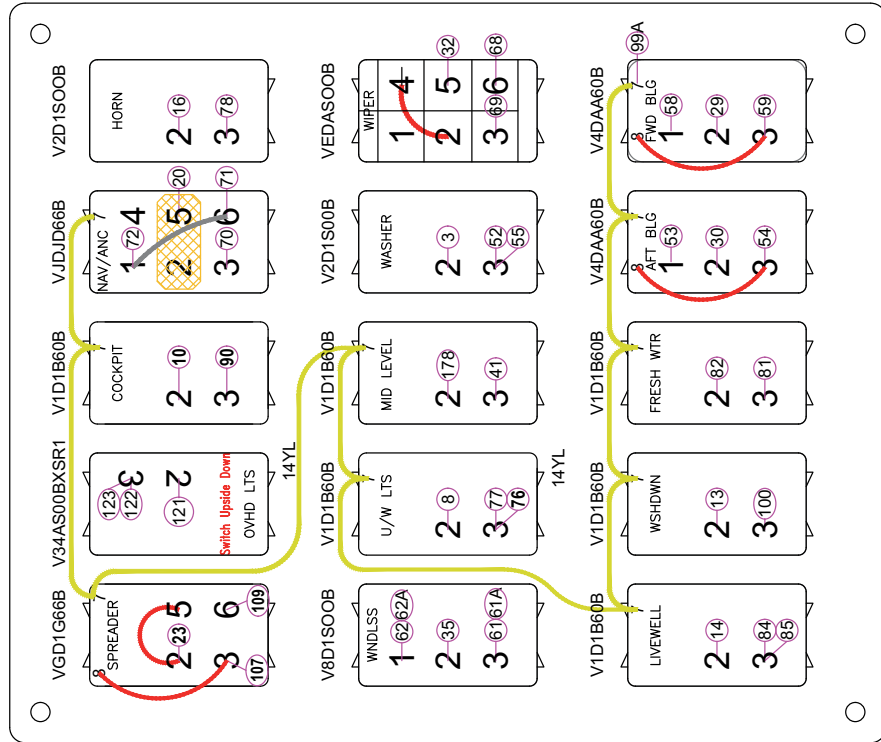

DC 246 (D4) 3509811 HELM PANEL TERMINATIONS

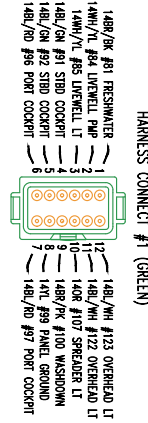

12WAY DEUTSCH DT RECEPTACLE  
 LT, GREEN CONNECTOR (DT04-12PC)  
 WEDGE LOCK (W12P)

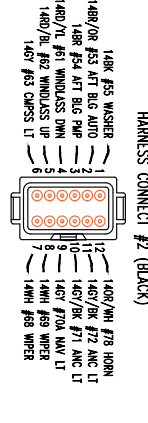

12WAY DEUTSCH DT RECEPTACLE  
 BLACK CONNECTOR (DT04-12PB)  
 WEDGE LOCK (W12P)

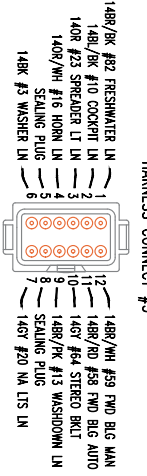

12WAY DEUTSCH DT RECEPTACLE  
 GRAY CONNECTOR (DT04-12PA)  
 WEDGE LOCK (W12P)

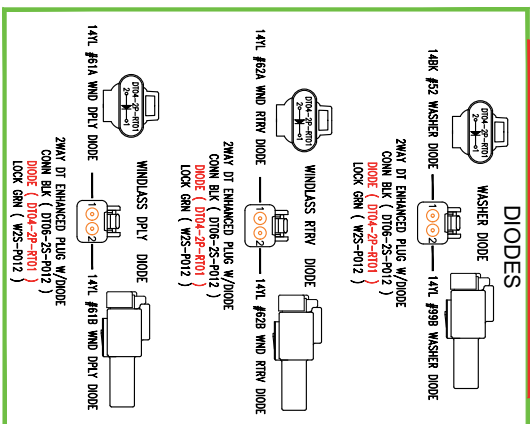
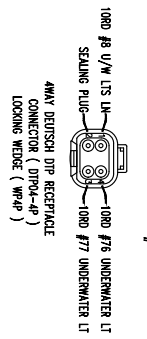
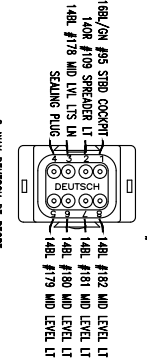
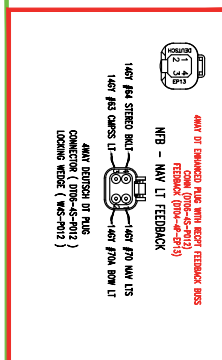
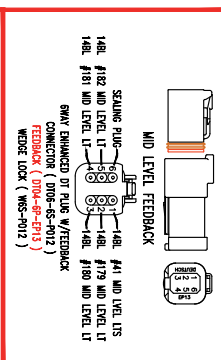
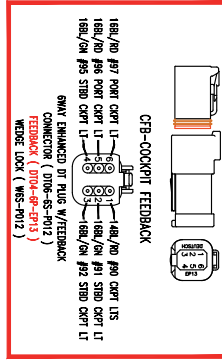
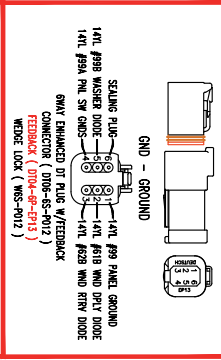
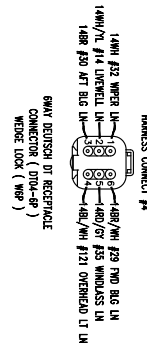

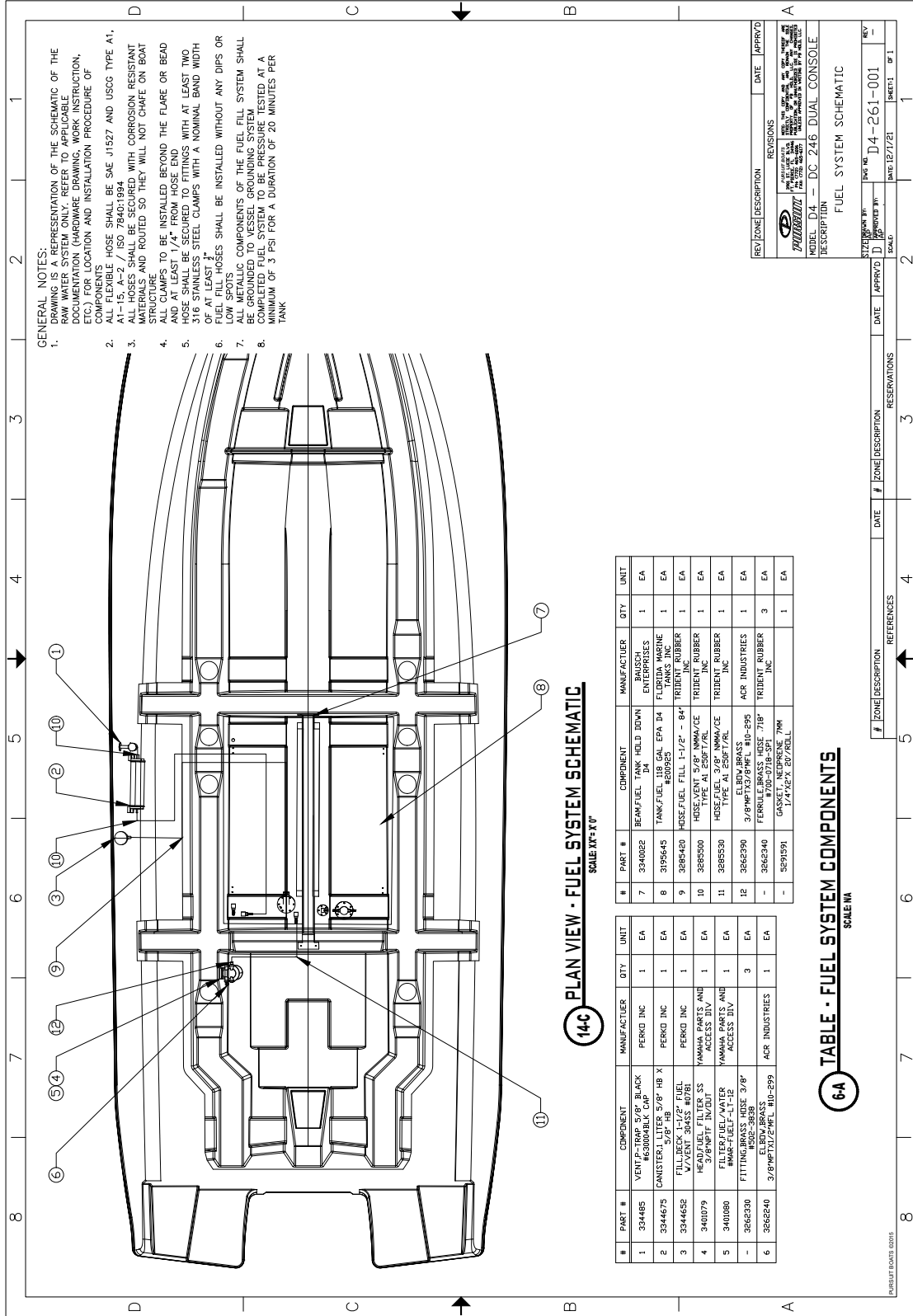

**6-A TABLE - FUEL SYSTEM COMPONENTS**  
SCALE: 1/4" = 1"

REV	ZONE	DESCRIPTION	DATE	APPROV'D
1	D	FUEL SYSTEM SCHEMATIC	12/17/21	[Signature]

STANDARD: DC 246 DUAL CONSOLE

DATE: 12/17/21

REV: D4-261-001

SHEET: 1 OF 1



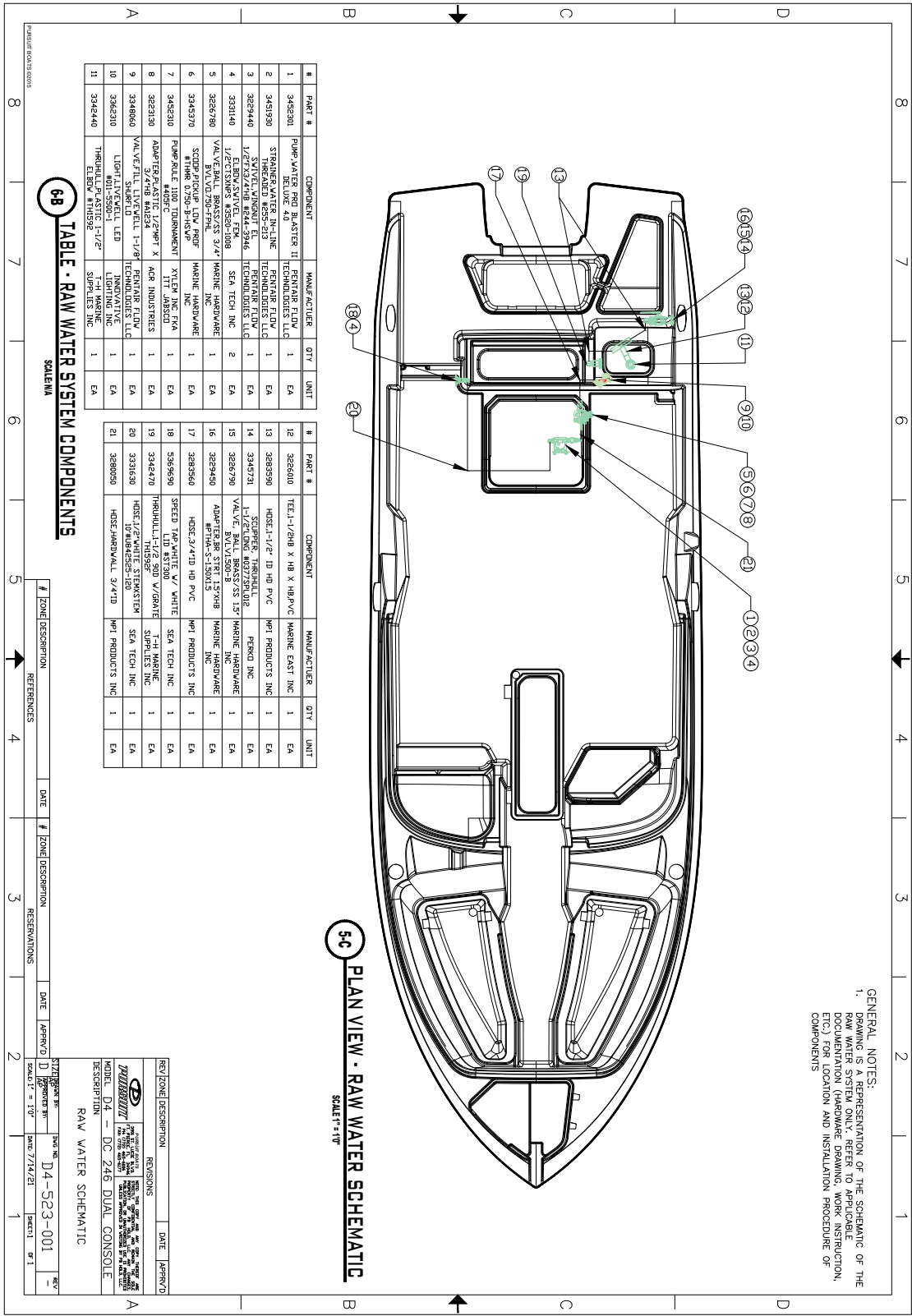

GENERAL NOTES:  
 1. DRAWING IS A REPRESENTATION OF THE SCHEMATIC OF THE RAW WATER SYSTEM ONLY. REFER TO APPLICABLE MANUFACTURER'S (FOR PUMP, VALVE, THRU-HULL, ETC.) FOR LOCATION AND INSTALLATION PROCEDURE OF COMPONENTS.

**5-C** PLAN VIEW - RAW WATER SCHEMATIC  
 SCALE: 1" = 10"

#	PART #	COMPONENT	MANUFACTURER	QTY	UNIT
1	34S201	PUMP WATER PUMP BASTER II	PERNAR ELECTRIC	1	EA
2	34S1930	STRAINER WATER 3/4" IN	PERNAR ELECTRIC	1	EA
3	3829440	THRU-HULL RESS-213	TECHNOLOGIES LLC	1	EA
4	3331440	1/2" ELBOW VALVE FEM	SEA TECH INC	2	EA
5	3826790	VALVE BALL BRASS/SS 3/4"	MARINE HARDWARE	1	EA
6	3345370	SCOOP PICKUP LID 280P	MARINE HARDWARE	1	EA
7	34S210	PUMP RALE 1100 TERNAMENT	XYLEM INC FFA	1	EA
8	3823130	ADAPTER ASKIC 1/2" X 3/4" HD HD1534	ACR INDUSTRIES	1	EA
9	3348600	VALVE TITL LIVEWELL 1-1/8"	PERNAR ELECTRIC	1	EA
10	3362310	LIGHT LIVEWELL LED #011-5500-1	INDUACTIVE INC	1	EA
11	3342440	THRU-HULL ASTIC 1-1/2" ELBOW 1119326	T-H MARINE SUPPLIES INC	1	EA

#	PART #	COMPONENT	MANUFACTURER	QTY	UNIT
12	3826610	TEC-1-1/2" HD X HB X HB PVC	MARINE EAST INC	1	EA
13	3826590	HOSE 1-1/2" ID HD PVC	MPI PRODUCTS INC	1	EA
14	3345721	SCOOPER THRU-HULL	PERNO INC	1	EA
15	3826790	VALVE BALL BRASS/SS 1/2" BVLV1500-B	MARINE HARDWARE	1	EA
16	3829450	ADAPTER STR 1.5" HD HD1534	MARINE HARDWARE	1	EA
17	3826560	HOSE 3/4" ID HD PVC	MPI PRODUCTS INC	1	EA
18	5369690	SPEED TAP WHITE V/WHITE	SEA TECH INC	1	EA
19	3342470	THRU-HULL RESS 2" W/GATE	T-H MARINE SUPPLIES INC	1	EA
20	3331630	HOSE 1/2" WHITE STEWASTEN	SEA TECH INC	1	EA
21	3826050	HOSE FIBERGLASS 3/4" ID	MPI PRODUCTS INC	1	EA

**68** TABLE - RAW WATER SYSTEM COMPONENTS  
 SCALE: 1" = 10"

#	ZONE DESCRIPTION	REFERENCES	DATE	#	ZONE DESCRIPTION	RESERVATIONS	DATE	APPROV'D	REV

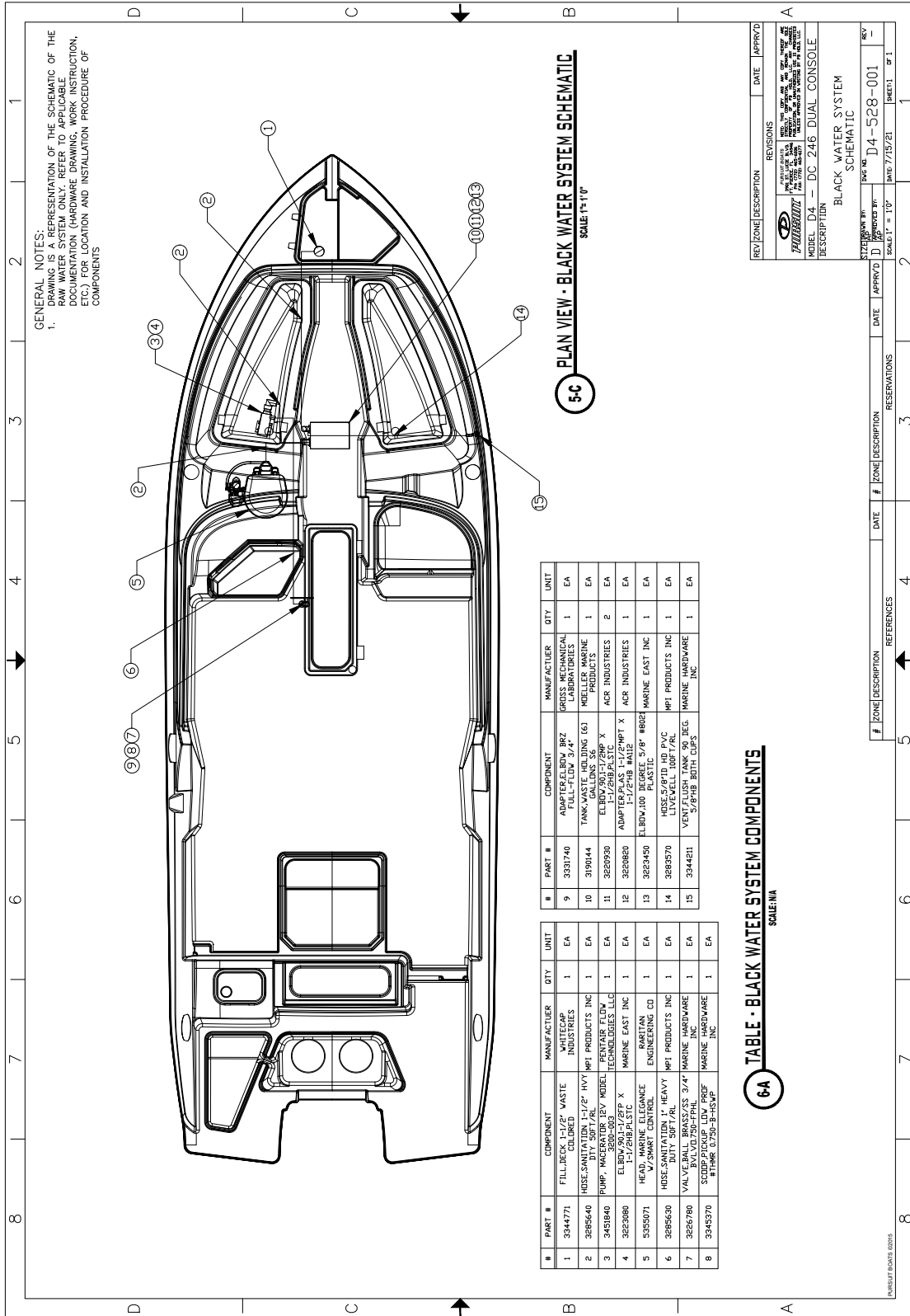

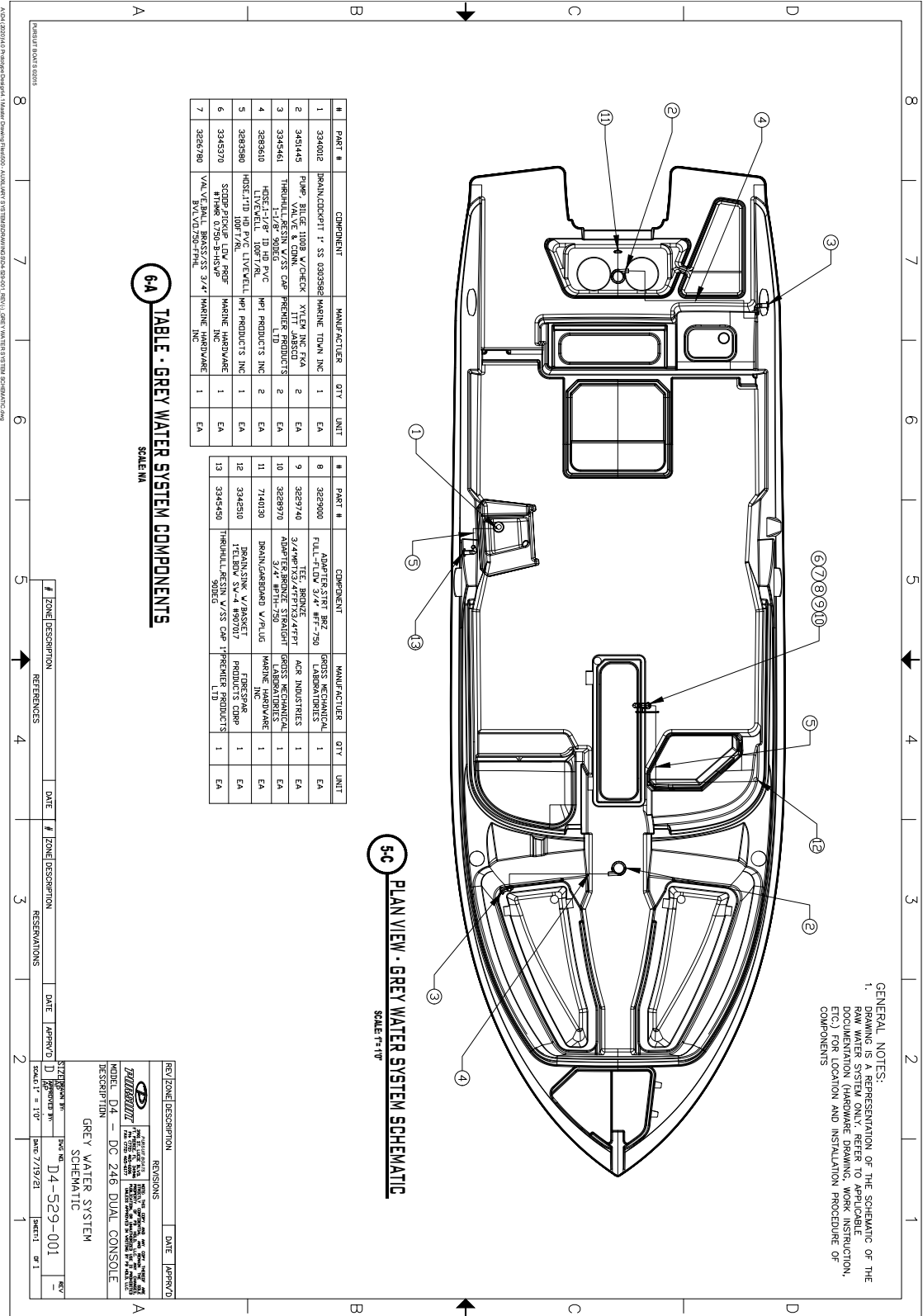

GENERAL NOTES:  
 1. DRAWING IS A REPRESENTATION OF THE SCHEMATIC OF THE RAW WATER SYSTEM ONLY, REFER TO APPLICABLE DOCUMENTATION (HARDWARE DRAWINGS, WORK INSTRUCTION, ETC.) FOR LOCATION AND INSTALLATION PROCEDURE OF COMPONENTS

**50 PLAN VIEW - GREY WATER SYSTEM SCHEMATIC**  
 SCALE 1/4"=1'

#	PART #	COMPONENT	MANUFACTURER	QTY	UNIT
1	334802	BRAIN/COOPRT 1" SS 803288	MARINE TOWN INC	1	EA
2	3451445	PUMP, BILGE 100B V/CHECK	XYLEM INC FKA	2	EA
3	3343461	THRUHULL RESIN V/SS CAP 1-1/2" 300EG	PRECHER PRODUCTS LTD	2	EA
4	3283860	RESIL V/CP 10.00 PVC	WPT PRODUCTS INC	2	EA
5	3283380	HDSL:JTD HD PVC LIVEWELL	WPT PRODUCTS INC	1	EA
6	3343370	SCHEM COUP LHM 450P	MARINE HARDWARE	1	EA
7	3282780	VALVE BALL BRASS/SS 3/4"	MARINE HARDWARE INC	1	EA
8	3223000	ADAPTER STR BRZ FULL-FLW 3/4" #7-750	IBISS MECHANICAL LABORATORIES	1	EA
9	3229740	TEE BRONZE 1/2" 441FT1	ACR INDUSTRIES	1	EA
10	3229770	ADAPTER BRONZE STRAIGHT 3/4" #7H-750	IBISS MECHANICAL LABORATORIES	1	EA
11	7140130	BRAIN/GARBOARD V/PLUG	MARINE HARDWARE	1	EA
12	3343510	BRAIN/SINK V/ASSET TEL.BOV SV-4 #90017 300EG	FIDRESMAR PRODUCTS CORP	1	EA
13	3344450	THRUHULL RESIN V/SS CAP	PRECHER PRODUCTS LTD	1	EA

**64 TABLE - GREY WATER SYSTEM COMPONENTS**  
 SCALE 1/4"=1'

#	ZONE DESCRIPTION	REFERENCES	DATE	#	ZONE DESCRIPTION	RESERVATIONS	DATE	APPROV'D
2	STANDARD			1	DC 246 DUAL CONSOLE		7/19/21	
1	SCALE 1/4" = 1'							

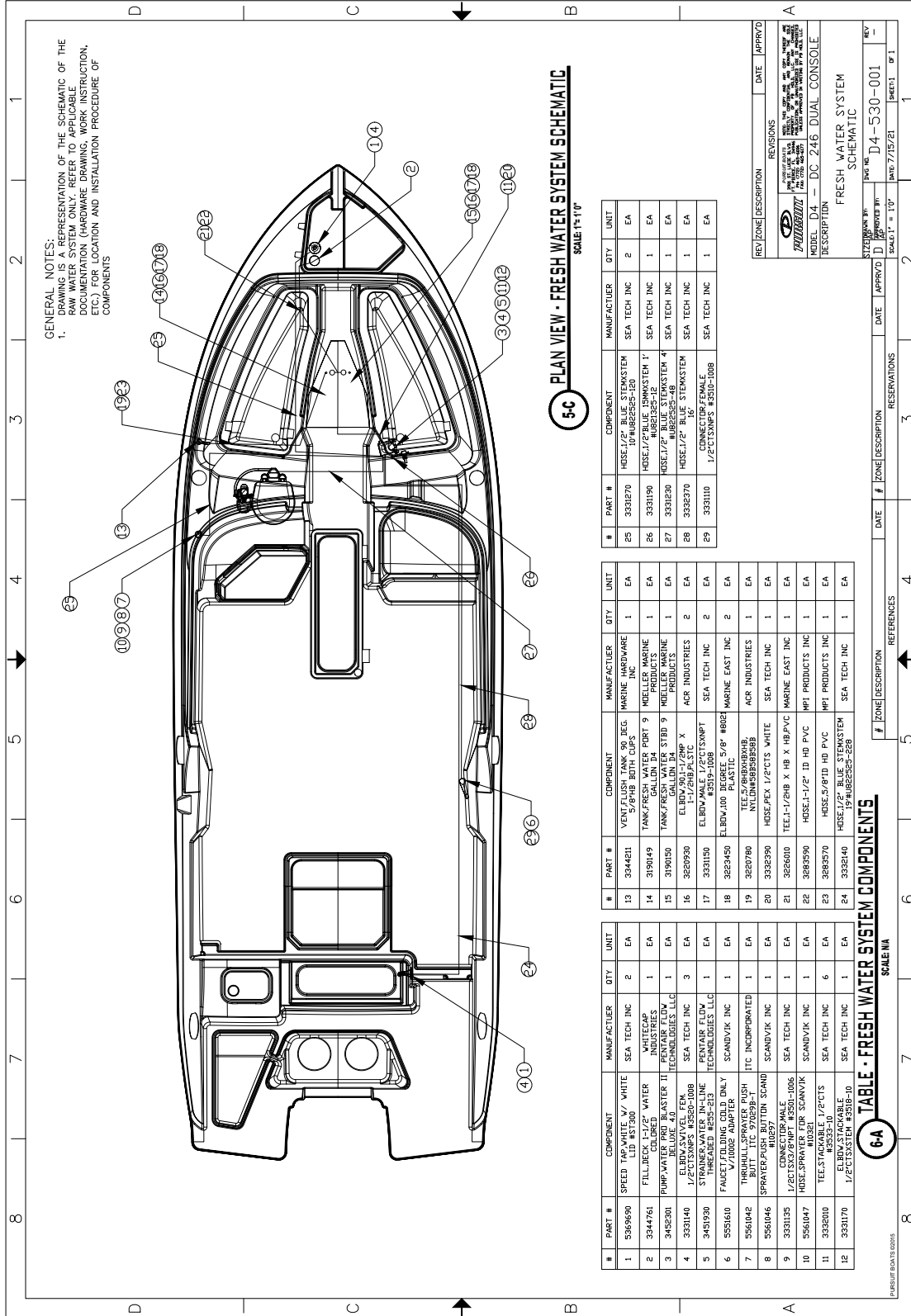

REV/ZONE	DESCRIPTION	DATE	APPROV'D
A	FRESH WATER SYSTEM SCHEMATIC		

#	PART #	COMPONENT	MANUFACTURER	QTY	UNIT
1	5386990	SPEED TAP/WHITE W/ WHITE	SEA TECH INC	2	EA
2	3344761	FILL BECK 1/2" WATER COLURED	WHITECAP INDUSTRIES	1	EA
3	3492301	PUMP/WATER PWR BLASTER II	TECHNICAL	1	EA
4	3531140	ELBOW/SWIVEL FEM. 1/2"CTS/NPS #350-1008	SEA TECH INC	3	EA
5	3491930	STRAINER WITH LINE FILTER	SEA TECH INC	1	EA
6	5551610	FAUCET/FOLDING COLD ONLY W/1000Z ADAPTER	SCANDVIK INC	1	EA
7	5561042	THRUHULL SPRAYER PUSH SPRAYER PUSH	ITC INCORPORATED	1	EA
8	5561046	SPRAYER PUSH BUTTON SCAND	SCANDVIK INC	1	EA
9	3331135	1/2"CTS/STAINLESS STEEL DOWNSPRAYER FOR SCANDVIK #1031	SEA TECH INC	1	EA
10	5561047	TEE/STAINLESS STEEL 1/2"CTS	SCANDVIK INC	6	EA
11	3332810	ELBOW/STACKABLE 1/2"CTS	SEA TECH INC	1	EA
12	3531170	ELBOW/STACKABLE 1/2"CTS	SEA TECH INC	1	EA
13	3344211	VEHICLE FRESH WATER TANK 9.5 GAL	MARINE HARDWARE	1	EA
14	3190449	TANK/FRESH WATER STBD 9 GAL	MUELLER MARINE PRODUCTS	1	EA
15	3190150	TANK/FRESH WATER PORT 9 GAL	MUELLER MARINE PRODUCTS	1	EA
16	3820930	ELBOW/90/1-1/2"HP X 1-1/2"HP PL/STC	ACR INDUSTRIES	2	EA
17	3331150	ELBOW/WATER TIGHT/STC/NPT	SEA TECH INC	2	EA
18	3822450	ELBOW/100 DEG/RE 5/8" #802	MARINE EAST INC	2	EA
19	3820780	TEE/2"RIB/80R/8H/11/16"IN/2555555555	ACR INDUSTRIES	1	EA
20	3522590	HOSE/PEX 1/2"CTS WHITE	SEA TECH INC	1	EA
21	3826010	TEE/1-1/2"HB X HB X HB/PVC	MARINE EAST INC	1	EA
22	3883590	HOSE/1-1/2" ID HD PVC	HPT PRODUCTS INC	1	EA
23	3883570	HOSE/2"ID HD PVC	HPT PRODUCTS INC	1	EA
24	3332140	HOSE/2" BLUE STEELSTEM 19"HB/5555-228	SEA TECH INC	1	EA
25	3332170	HOSE/1/2" BLUE STEELSTEM 16"	SEA TECH INC	1	EA
26	3332190	HOSE/1/2" BLUE STEELSTEM 12"	SEA TECH INC	1	EA
27	3332130	HOSE/1/2" BLUE STEELSTEM 4"	SEA TECH INC	1	EA
28	3332170	HOSE/1/2" BLUE STEELSTEM 16"	SEA TECH INC	1	EA
29	3333110	1/2"CTS/NPS #350-1008	SEA TECH INC	1	EA

#	ZONE DESCRIPTION	DATE	APPROV'D	RESERVATIONS
1				

#	ZONE DESCRIPTION	DATE	APPROV'D	RESERVATIONS
1				

  

SIZE	DATE	BY	NO.
D4-530-001	7/15/21		

  

REV	DATE	BY	NO.
1	7/15/21		

**6-A TABLE - FRESH WATER SYSTEM COMPONENTS**  
 SCALE: N/A

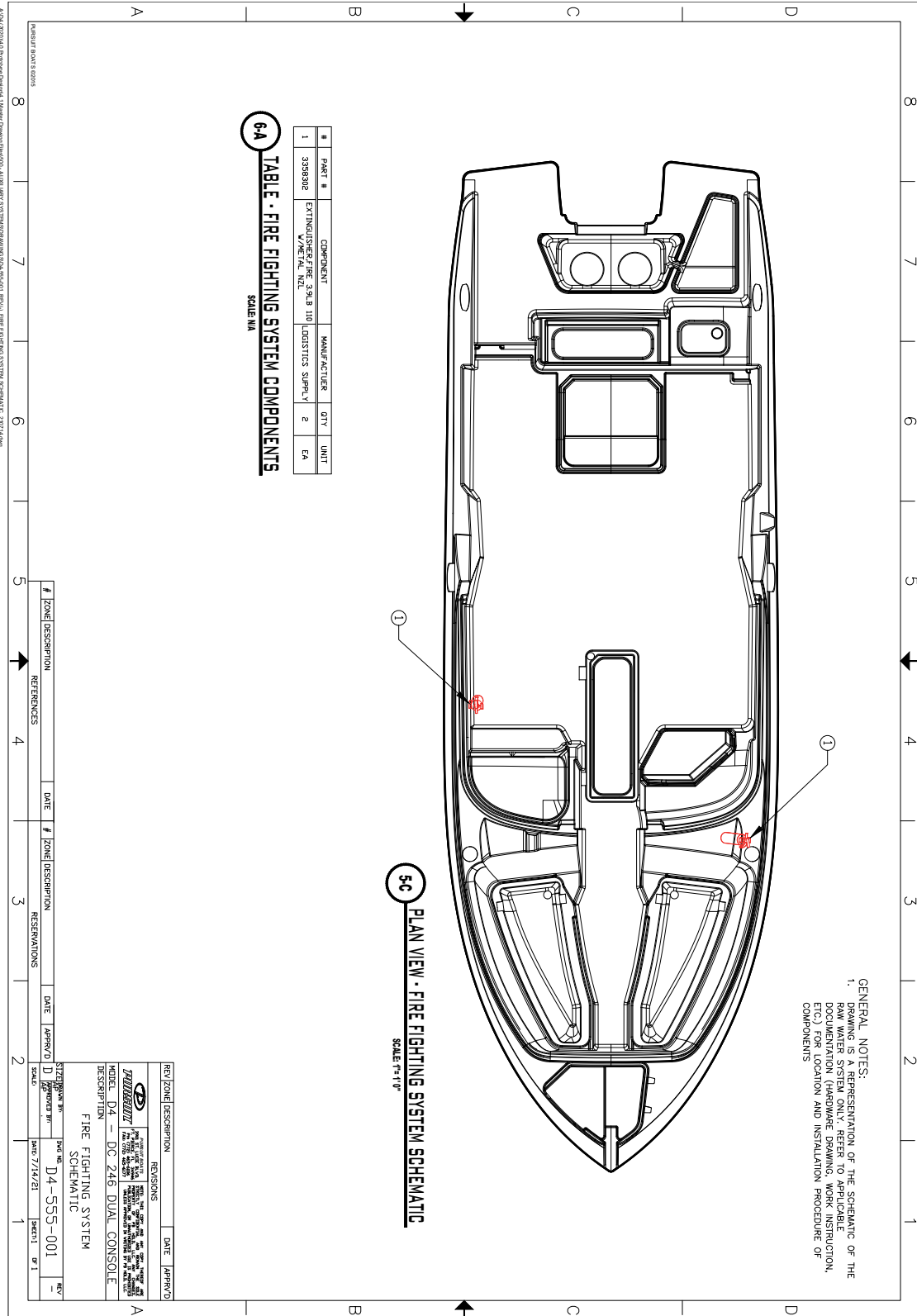

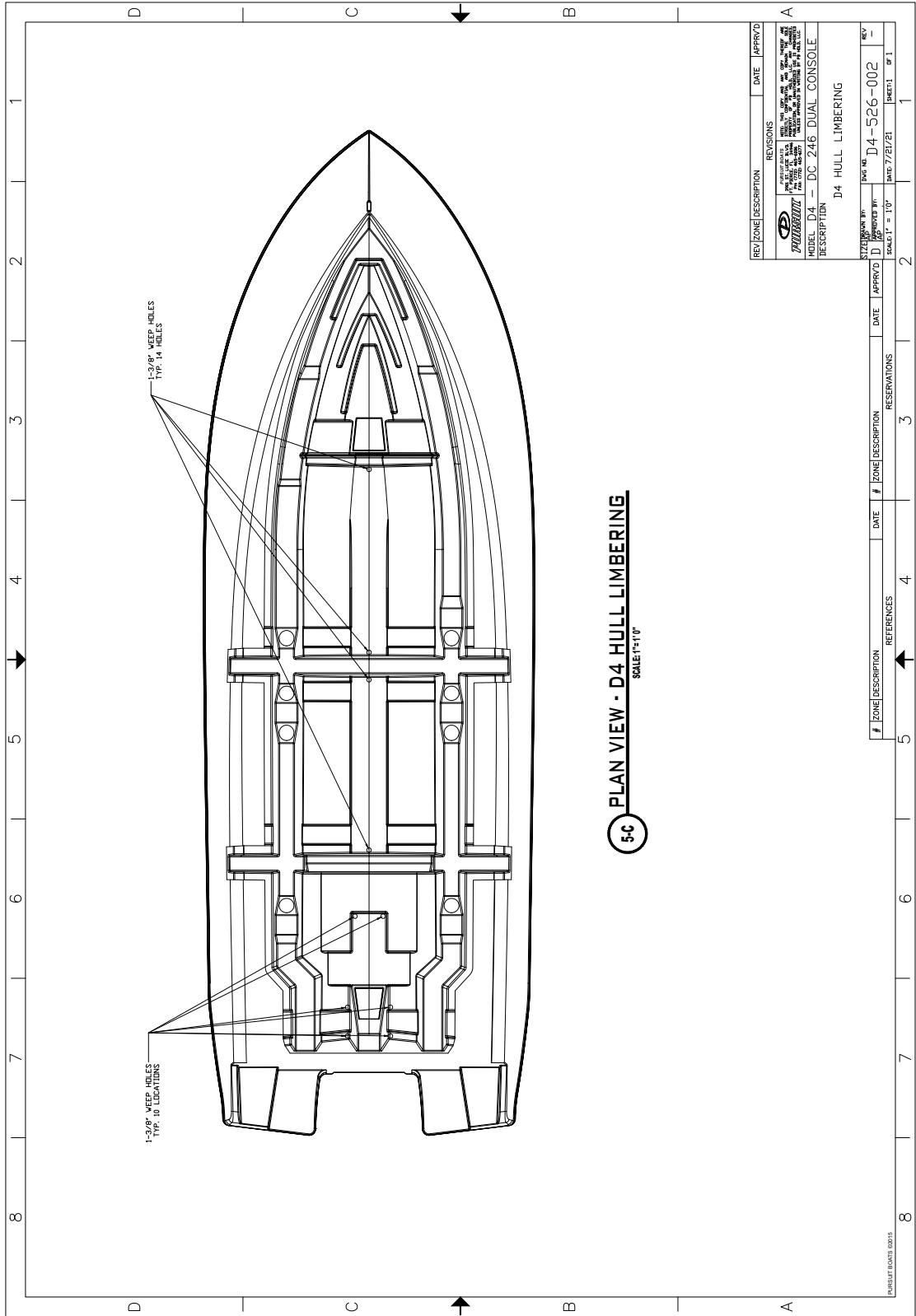

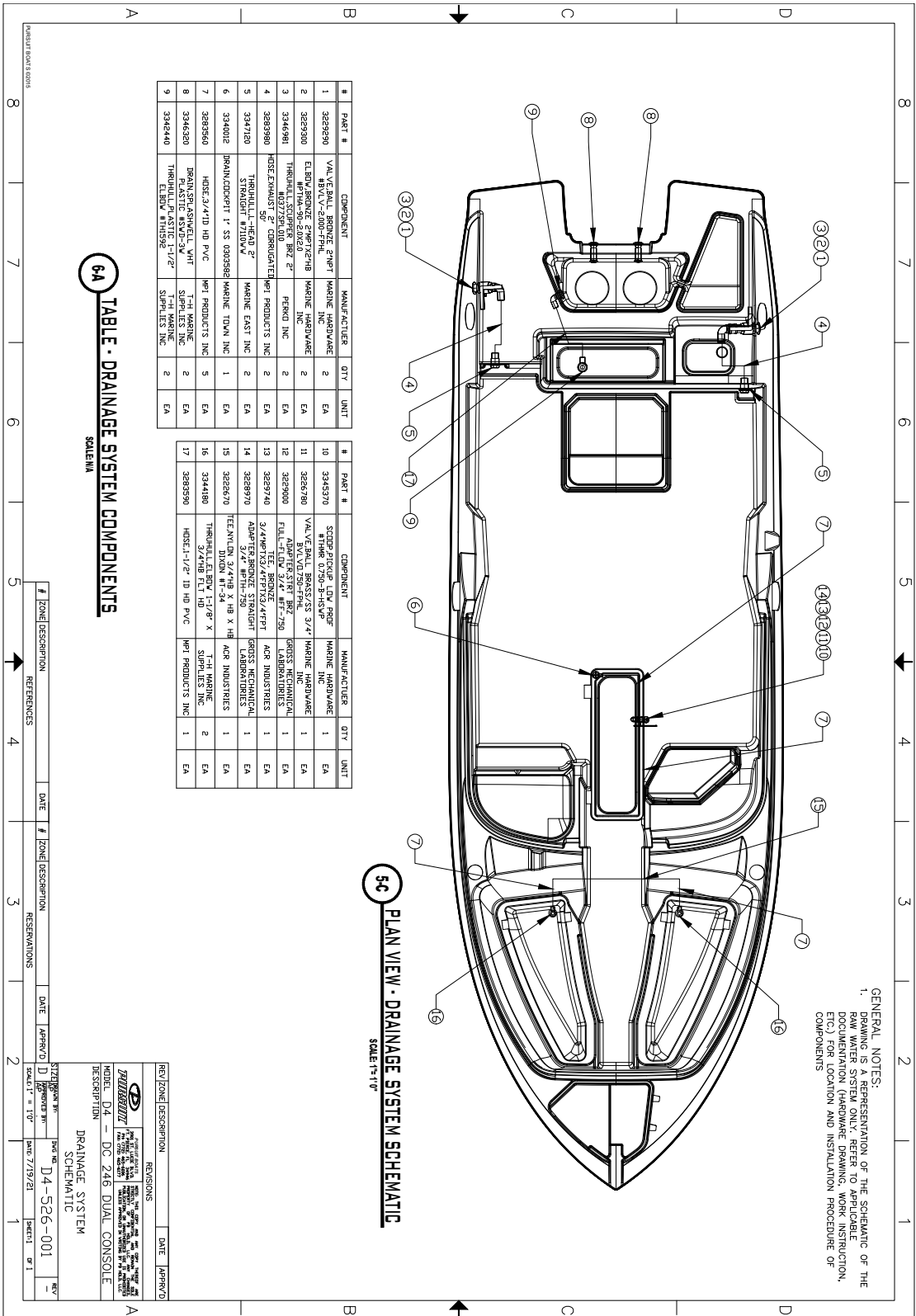

**GENERAL NOTES:**  
 1. DRAWING IS A REPRESENTATION OF THE SCHEMATIC OF THE DRAIN SYSTEM ONLY. REFER TO APPLICABLE INSTRUCTION SHEET (AND/OR INSTALLATION PROCEDURE, ETC.) FOR LOCATION AND INSTALLATION PROCEDURE OF COMPONENTS.

#	PART #	COMPONENT	MANUFACTURER	QTY	UNIT
1	3829290	VALVE BALL BRONZE 2"HP	MARINE HARDWARE INC	2	EA
2	3829200	ELBOW BRONZE 2"HPX2"HB	MARINE HARDWARE INC	2	EA
3	3344391	THRUSHAFT COUPLER BRZ 2"	PERKO INC	2	EA
4	3883980	HOSE EXHAUST 2" CORRUGATED	MPI PRODUCTS INC	2	EA
5	3341280	THRUSHAFT HEAD 2" STRAIGHT W/10WV	MARINE EAST INC	2	EA
6	3344002	HOSE 3/4"ID HD PVC	MPI PRODUCTS INC	5	EA
7	3883560	BRAIN SPLASHWELL VHT	T-H MARINE SUPPLIES INC	2	EA
8	3346280	THRUSHAFT ASTIC 1-1/2"	T-H MARINE SUPPLIES INC	2	EA
9	3344440	THRUSHAFT ASTIC 1-1/2"	T-H MARINE SUPPLIES INC	2	EA
10	3344370	SCOP PUMP LOW PWR	MARINE HARDWARE INC	1	EA
11	3826790	VALVE BALL BRASS/CS 3/4"	MARINE HARDWARE INC	1	EA
12	3829040	FULL FLOW 3/4" W/F-750	GROSS MECHANICAL LABORATORIES	1	EA
13	3829740	3/4"HP/2" BRONZE 3/4"FT	AGR INDUSTRIES	1	EA
14	3828970	ADAPTER BRONZE STRAIGHT 3/4" W/H-750	GROSS MECHANICAL LABORATORIES	1	EA
15	3828670	FEELNDRN 3/4"HB X HB X HB	AGR INDUSTRIES	1	EA
16	3344180	THRUSHAFT BOW 1-1/8" X 3/4"HB FLI HD PVC	T-H MARINE SUPPLIES INC	2	EA
17	3883590	HOSE 1-1/2" ID HD PVC	MPI PRODUCTS INC	1	EA

**TABLE - DRAINAGE SYSTEM COMPONENTS**  
 SCALE: 1/4" = 1"

**6A**

**DRAINAGE SYSTEM SCHEMATIC**

REV: ZONE DESCRIPTION REVISIONS DATE: APPROV/D

MODEL: D4 - DC 246 DUAL CONSOLE

DATE: 7/19/21

SHEET 1 OF 1

DATE: APPROV/D

DATE: APPROV/D

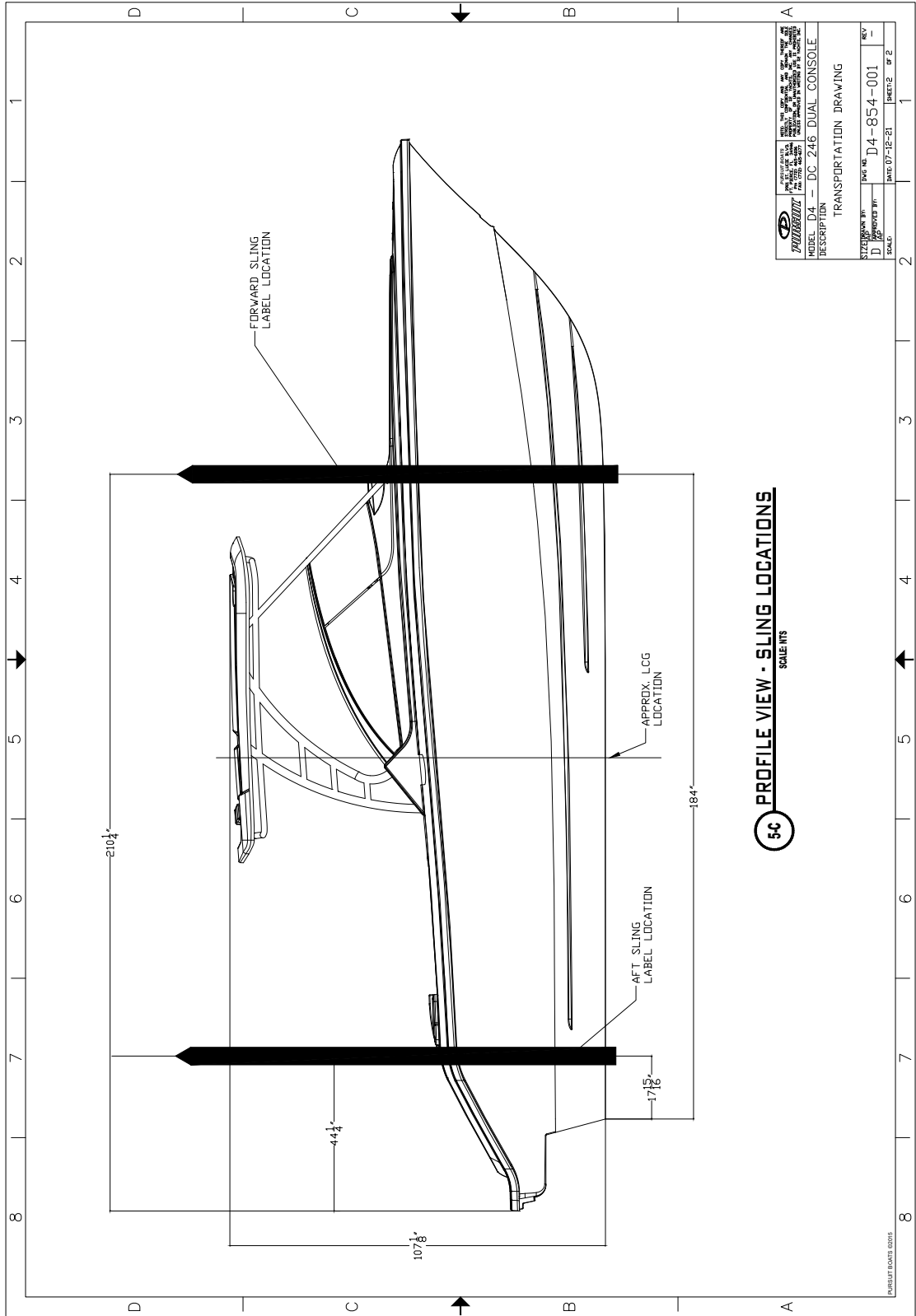



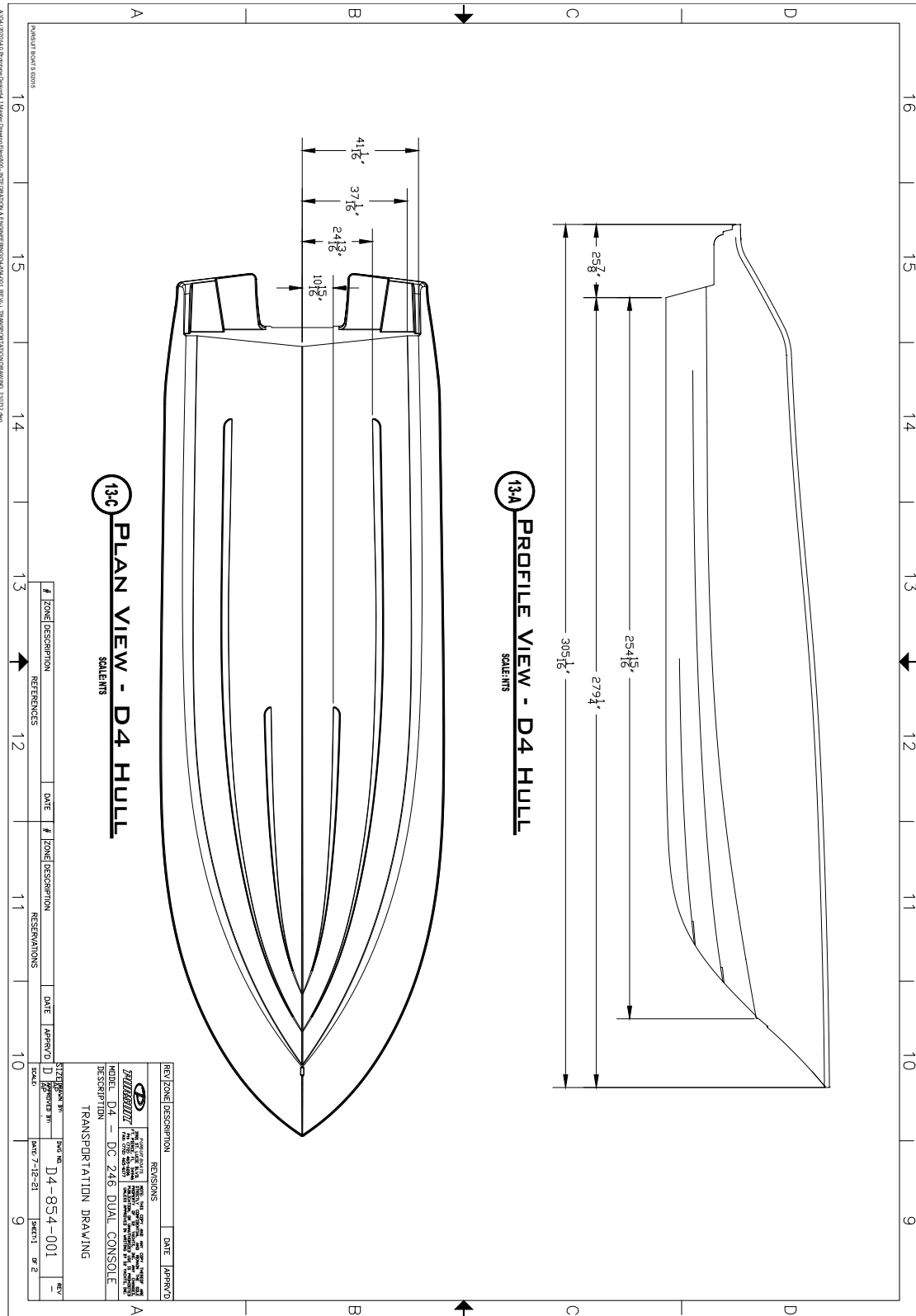

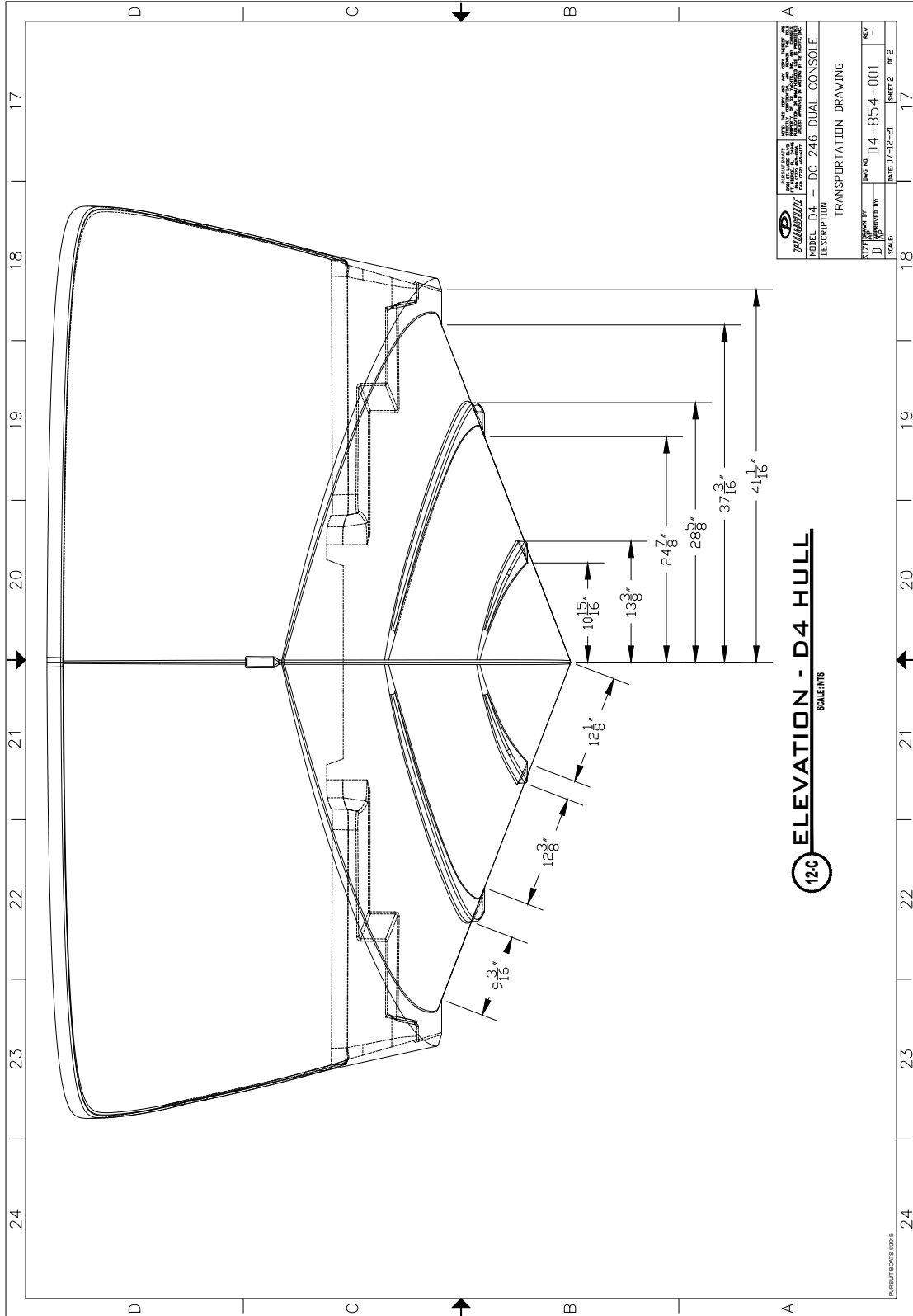



## Fresh Water System

The fresh water system must be disinfected before first use and yearly at the beginning of each season. A clean sanitized fresh water system will greatly reduce the risk of developing coliform bacteria or other disease-causing organisms (pathogens) and will help protect the health of everyone onboard.

### **WARNING**

**DISINFECT THE ENTIRE FRESH (POTABLE) WATER SYSTEM PRIOR TO USE AND YEARLY AT THE BEGINNING OF EACH SEASON. FAILURE TO DO SO CAN RESULT IN DEVELOPING COLIFORM BACTERIA OR OTHER DISEASE-CAUSING ORGANISMS (PATHOGENS) IN THE WATER SYSTEM. CONSUMPTION OF CONTAMINATED WATER COULD RESULT IN SEVERE PERSONAL INJURY OR DEATH.**

**Follow this procedure to disinfect the fresh water system, kill bacteria that may be present, and prepare the system for operation:**

Note: The fresh water system may be filled with nontoxic potable water antifreeze. If antifreeze was not used, skip to step 7.

1. Turn both water heater valves to the normal operation position.
2. Open all faucets (hot & cold), setting single faucets to the warm position.
3. Switch ON the FRESH WATER PUMP breaker(s), located on the DC Distribution Panel. The pumps are self-priming.
4. When anti-freeze stops flowing out of the faucets, switch the pump breaker(s) OFF. Do not close faucets.
5. Fill the fresh water tank with clean, fresh water. The fill fitting for the water tank is on the deck amidships, labeled WATER. The tank should be filled until water runs out of the vent located on the hull side just below the fill.
6. Keeping all faucets open, switch the FRESH WATER PUMP breaker(s) ON and empty the water tank. When the water tank is empty turn the pump breaker(s) OFF.
7. Repeat steps 5 and 6 until all nontoxic potable water antifreeze is removed from the system.

8. Ensure the water system, including the water heater and pump(s), is drained completely.
9. Close all faucets.

**⚠ CAUTION**

**Notify all persons aboard that the fresh water system is being sanitized. Do not allow anyone to drink from the fresh water system during the sanitizing process.**

10. Prepare a chlorine sanitizing solution: in a container with 1 gallon of fresh water, mix 1/4 cup of Clorox® or Purex® regular unscented household bleach (5% sodium hypochlorite solution) for each 15 gallons of water tank capacity (**Table A-1**).

**Table A-1: Tank capacity vs. cups of bleach**

Water Tank Capacity	Cups of Bleach
15 Gal.	1/4 Cup
30 Gal.	1/2 Cup
45 Gal.	3/4 Cup
60 Gal.	1 Cup
75 Gal.	1-1/4 Cups
90 Gal.	1-1/2 Cups
105 Gal.	1-3/4 Cups
120 Gal.	2 Cups
135 Gal.	2-1/4 Cups
150 Gal.	2-1/2 Cups

11. Fill the fresh water tank halfway with clean, fresh water.
12. Pour the sanitizing solution into the water tank through the deck WATER fill fitting.
13. Fill the remainder of the tank with clean, fresh water. The tank should be filled until water runs out of the vent. (See step 5.)

14. Switch ON the FRESH WATER PUMP breaker(s).
15. At each faucet, run about 1/2 gallon of water out of each tap (hot and cold), then close the tap. You should be able to smell chlorine out of each tap.
16. Switch OFF the FRESH WATER PUMP breaker(s).
17. **Allow the chlorine sanitizing solution to sit in the system for three (3) hours.** A shorter time period will require a greater concentration of chlorine sanitizing solution to disinfect the water system.
18. Switch ON the FRESH WATER PUMP breaker(s).
19. Drain the chlorine sanitizing solution by opening all faucets (hot & cold), setting single faucets to the warm position, and empty the water tank. When the water tank is empty turn the pump breaker(s) OFF.
20. Ensure the water system, including the water heater and pump(s), is drained completely.
21. Fill the fresh water tank with clean, fresh water. The tank should be filled until water runs out of the vent. (See step 5.)
22. Keeping all faucets open, switch the FRESH WATER PUMP breaker(s) ON and empty the water tank. When the water tank is empty turn the pump breaker(s) OFF.
23. Repeat steps 21 and 22.
24. Final fill: Fill the fresh water tank with clean, fresh water. The tank should be filled until water runs out of the vent. (See step 5.)
25. Turn the FRESH WATER PUMP breaker(s) ON
26. Open each faucet. When a smooth flow of water is observed from each hot and cold tap, close the faucet. When all faucets are closed, the pumps will shut off as the system pressure increases. Any air should now be purged from the system. Leave the FRESH WATER PUMP breaker(s) ON.

**The fresh water system is now commissioned and ready for use.**

To remove excessive chlorine taste or odor that might remain in the system, do the following:

1. Ensure the water tank has enough available capacity to accept 10 additional gallons. If there is ample room in the tank, proceed to step 3, below.
2. Drain at least 10 gallons of water out of the system so the following vinegar solution will have room to be added. To do this switch ON the FRESH WATER PUMP breaker(s) and open a faucet. When at least 10 gallons has been drained, close the faucet and turn the pump breaker(s) OFF.
3. Prepare a solution of one (1) quart vinegar to five (5) gallons fresh water.
4. Pour the vinegar solution into the water tank through the deck WATER fill fitting.
5. Repeat steps 3 and 4.
6. Allow the vinegar solution to agitate in the tank for 24 hours.
7. Switch ON the FRESH WATER PUMP breaker(s).
8. Drain the vinegar solution by opening all faucets (hot & cold), setting single faucets to the warm position, and empty the water tank. When the water tank is empty turn the pump breaker(s) OFF.
9. Close all faucets.
10. Fill the fresh water tank with clean, fresh water. The fill fitting for the water tank is on the deck amidships, labeled WATER. The tank should be filled until water runs out of the vent located on the hull side just below the fill.
11. Turn the FRESH WATER PUMP breaker(s) ON
12. Open each faucet. When a smooth flow of water is observed from the hot and cold tap, close the faucet. When all faucets are closed, the pumps will shut off as the system pressure increases. Any air should now be purged from the system. Leave the FRESH WATER PUMP breaker(s) ON.
13. Repeat if necessary.

## Aquatic Invasive Species

Aquatic invasive species (AIS) are plants and animals that occur in waters in which they are not native and whose introduction causes or is likely to cause economic or environmental damage or harm to human health. AIS have a negative impact on the waterway, its native species, and recreational and commercial uses of the waterway. As responsible boaters and citizens, each boat owner should do their part to prevent the spread of these aquatic hitchhikers. In many cases, it is also required by law. Check local regulations for any waterway where you will boat. After each boating trip, follow these three simple steps before you leave the water access to stop the spread of AIS: Clean, Drain, and Dry. This is the boater's way to help protect the environment from the damage that AIS can cause.



**STOP AQUATIC  
HITCHHIKERS!™**

Be A Good Steward.  
Clean. Drain. Dry.

[StopAquaticHitchhikers.org](http://StopAquaticHitchhikers.org)

### PATHWAYS OF AQUATIC INVASIVE SPECIES

We are living in a very different era where goods, people and services are being shipped around the world. Because of this globalized economy, different species are hitchhiking through many different pathways. Species can be moved to new locations in many ways, and most are a result of human activity, including recreational activities. Some common ways that species may be moved during recreational boating and other activities include:

Attaching to watercraft, trailers, motor, and fishing gear.

Transport by water ballast water, bilge, and other water containing devices.



Dumping of unwanted live bait.  
Tangled in fishing lines and downrigger cables  
Sticking to the soles of waders  
Trapped in mud on a dog's paws

Just one organism, or in some case a piece of a plant, is enough to start a new invasion.

### GENERAL CLEAN DRAIN DRY PROCEDURE

Clean, Drain, Dry... In every waterbody, every time.

Preventing the spread of aquatic invasive species starts with you. A cooperative effort is necessary by all persons and agencies involved with recreational activities to achieve the best results and protect our aquatic resources and recreational opportunities. The general Clean Drain Dry procedure is described below:

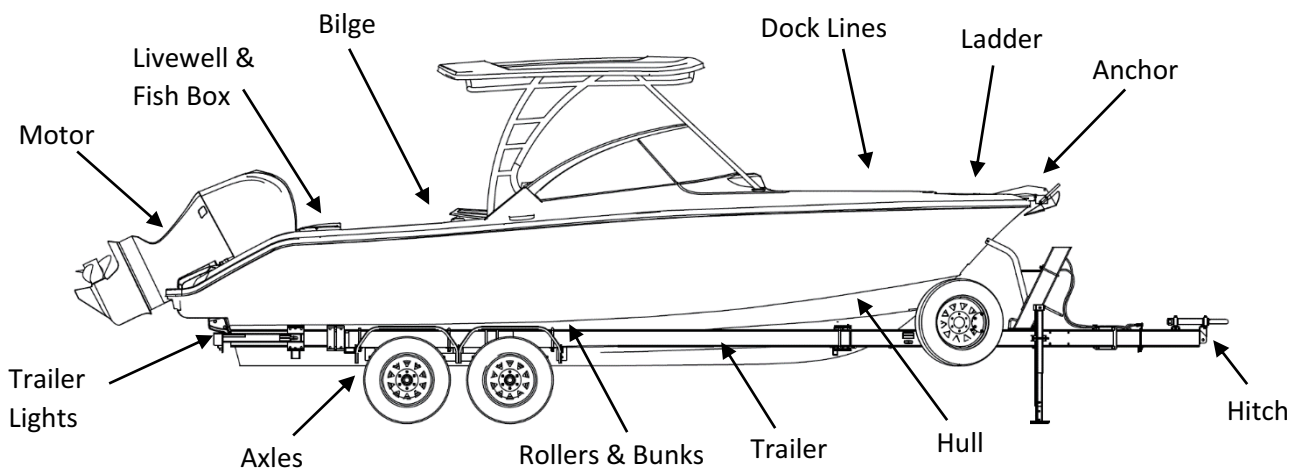

### CLEAN

Clean off visible aquatic plants, animals, and mud from all equipment before leaving water access. Inspect and clean motor or engine, including the lower unit and motor

mounts; trailer, including axles, bunks, and rollers; anchors; dock lines; and equipment before leaving the water body.

Rinse equipment and boat hulls (with high pressure, hot water when possible)

Rinse interior compartments of boats with low pressure, hot water (120°F) for a minimum of 130 seconds contact time.

Flush motor with hot water (120°F) for 2 minutes (or according to owner's manual)

## **DRAIN**

Drain the motor, motor cooling system, bilge, live well, fish box, and other water containing devices before leaving water access.

## **DRY**

Allow the boat to completely dry OR wipe with a towel before reuse, before visiting any other bodies of water. For ANGLERS, the additional step of DISPOSE is recommended.

## **DISPOSE**

Dispose of unwanted bait, worms, and fish parts in the trash. When keeping live bait, drain bait container and replace with spring or dechlorinated tap water. Never dump live fish or other organisms from one water body into another. Together the three steps of Clean Drain Dry greatly minimizes the risk of spreading Aquatic Hitchhikers into new locations.

Cleaning will remove visible large-bodied organisms attached to or in watercraft or recreational equipment. Rinsing with water removes organisms, while hot water often kills them. Water at least 120°F is recommended; be sure to avoid contact with skin and check manufacturers' recommendations to ensure equipment can withstand high temperatures. If hot water is not available or may cause damage, rinsing with tap water and completely drying will help prevent spread of aquatic invasive species.

Draining removes small and nearly invisible organisms such as zebra mussel larvae (veligers) potentially entrained in water containing devices.

Drying is necessary as many organisms can survive in standing water.

A note about chemicals. The use of chemical prophylactics or disinfectants (e.g., bleach) are not recommended for treating watercraft and recreational equipment. Chemicals may:

- Damage equipment or components

- Cause environmental damage

- Harm human health

- May not be effective against many aquatic invasive species

Report new sightings. If you think you have found an invasive species, note its exact location and, if possible, take a photo. Report new sightings to the appropriate authorities or use the USGS Sighting Report Form.

Know the rules! Specimens are needed to confirm sightings, but some jurisdictions prohibit possession and transport of invasive aquatic plants and animals. Before collecting specimens, contact your local natural resource management agency for instructions. Unauthorized introduction of plants, fish, or invertebrates into the wild is illegal in most states. Protect your property and our waters.

Remember that AIS Threaten the Environment, Recreation, Economy, and Human Health. Refer to the Stop Aquatic Hitchhikers! Website for more details ([www.StopAquaticHitchhikers.org](http://www.StopAquaticHitchhikers.org)).



***PURSUIT***®